



Road Safety Data, Collection, Transfer and Analysis

D2.3 Training Package including training manual and draft protocols

Please refer to this report as follows:

Atalar, D., Talbot, R., Hill, J. (Eds) (2012) Training Package including training manual and draft protocols, Deliverable 2.3 of the EC FP7 project DaCoTA.

Grant agreement No TREN / FP7 / TR / 233659 / "DaCoTA"

Theme: Sustainable Surface Transport: Collaborative project

Project Coordinator:

Professor Pete Thomas, Transport Safety Research Centre, Loughborough Design School, Loughborough University, Ashby Road, Loughborough, LE11 3TU, UK

Project Start date: 01/01/2010

Duration 30 months

Organisation name of lead contractor for this deliverable:

Transport Safety Research Centre (TSRC)

Report Author(s):

Helen Fagerlind and Joel Armstrong, SAFER
Deniz Atala, Elizabeth Dodson, Rachel Talbot, Julian Hill, TSRC
Mathieu Roynard, Heike Martensen, IBSR
Michael Jänsch, MUH
Dimitris Margaritis, HIT
Anuncia Ocampo Sánchez, DGT
Javier Pàez, INSIA
Adrià Ferrer, IDIADA
Pierre Van Elslande and Christophe Perrin, IFSTTAR
Thierry Hermitte, LAB
Gabriele Giustiniani, CTL
Ragnhild Davidse, SWOV

Due date of deliverable

31/03/2012

Submission date:

7/11/2012

Project co-funded by the European Commission within the Seventh Framework Programme

Dissemination Level

PU

Public

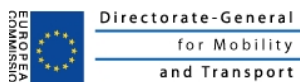

Project co-financed by the European Commission Directorate General for Mobility and Transport

TABLE OF CONTENTS

Acknowledgments	4
Executive summary	5
1. Draft On-line Manual.....	6
1.1. Introduction.....	6
1.2. DaCoTA Teams	8
DaCoTA Team Structure	8
Equipment	8
Arrangements	8
Database Variables	9
Team Experience	10
Methods.....	11
1.3. Variables	18
1.4. Methodology Outline	19
1. Sampling Plan.....	19
2. Team Safety	20
3. Accident Notifications.....	21
4. Scene and Road.....	21
5. Vehicle Inspection.....	22
6. Vulnerable Road Users.....	23
7. Behavioural Data.....	24
8. Medical Data	25
9. Accident Causation	26
10. Accident Reconstruction.....	26
11. Case Delivery	27
1.5. Detailed Methodology	28
1. Sampling Plan.....	29
2. Health and Safety.....	30
3. Accident Notifications.....	36
4. Photo Routine	37
5. Scene and Road.....	42
a. Scene Measurements.....	47
b. Scene and Road Sketch	51
6. Vehicle Inspection.....	52
7. Vulnerable Road User	58
8. Behavioural Data.....	59
9. Medical Data	65
10. Accident Causation	66
12. Case Delivery	69
13. Equipment List.....	70
1.6. Forms and Documents	73
2. Training Package.....	74
2.1. Introduction.....	74
2.2. Preparing an Investigation Team.....	75
Objectives	75
Scope of the training.....	75

2.3	<i>Scene Examination and recording visual evidence about the crash scene</i>	76
	Objectives	76
	Scope of the training.....	76
	Presentation	76
	Practical session.....	76
	Database and wiki.....	77
	Available documents on scene/site examination	77
2.4.	<i>Vehicle Examination</i>	78
	Objectives	78
	Scope of the training.....	78
2.5.	<i>Vulnerable Road Users</i>	81
	Objectives	81
	Scope of the training.....	81
	Presentation - Field training	81
	Information provided in the presentations of the Theoretical session	81
	Field training	81
	Database and Online Manual	82
2.6.	<i>Collecting Road User Data</i>	83
	Objectives	83
	Scope of the Training.....	83
2.7.	<i>Medical information</i>	84
	Objectives	84
	Scope of the training.....	84
	Presentation	84
	Database and wiki.....	85
2.8.	<i>Case Analysis</i>	86
	Objectives	86
	Scope of the training.....	86
	Training Course	87
3.	Appendix to the Training Package	88
3.1.	<i>Training Presentations</i>	88

ACKNOWLEDGMENTS

The DaCoTA partnership would like to acknowledge the contribution of SAFER to this work. The Online Manual was developed from a system created by SAFER for the Swedish in-depth investigation activities. This system was given to DaCoTA for modification and use in its in-depth investigation activities.

Special thanks go to the many individuals in addition to those named as authors who have contributed to this work from the following institutions:

- Belgium: Belgian Road Safety Institute (IBSR)
- Germany: Medical University of Hannover (MUH)
- Greece: National Technical University of Athens (NTUA), Hellenic Institute of Transport (HIT)
- Spain: Jefatura Central de Tráfico (DGT), Institute f. automobile Research (INSIA), Applus IDIADA
- France: French Institute of science and technology (IFSTTAR), Laboratoire d'Accidentologie (LAB)
- The Netherlands: Institute for Road Safety Research (SWOV)
- Sweden: Vehicle and Traffic Safety Centre (SAFER)
- United Kingdom: Transport Safety Research Centre (TSRC)

In particular thanks go to the following individuals for their contributions to the DaCoTA training:

Francisco J. Lopez-Valdes,(European Centre for Injury Prevention/University of Virginia), Eduardo del Pozo (IDIADA), Maria Segui-Gomez and Alvaro Gomez, (DGT), Mikael Ljung-Aust (Volvo Car Corporation) and Database:

Roberto Carroccia and Massimo Robibaro (CTL)

EXECUTIVE SUMMARY

This deliverable is intended to collate the DaCoTA training manual and draft protocols for in-depth road accident investigations in Europe. This deliverable aims at producing a document that will be used in the training of new and previously experienced teams in the realm of in depth accident data collection.

The document is divided into 2 main sections. The first presents the DaCoTA Training Manual and the second presents the DaCoTA training materials. These materials were used as a basis for developing a training protocol for the Pan European In depth Accident Investigation Network. The training materials were used to train the new member teams with regards to the DaCoTA accident investigation protocols highlighting the DaCoTA database as the main tool to use when inputting data.

The DaCoTA training manual outlines all of the variables that are required to be gathered during in depth accident investigation and inputted into the DaCoTA database. This manual is available online at the web address <http://dacota-investigation-manual.eu/>. Credentials to these documents are available from the DaCoTA network partners on request.

The DaCoTA training materials were developed by the Pan European In depth accident network to train new teams in the DaCoTA protocols for in depth accident investigation. These materials were used during the DaCoTA training week which was held at the IDIADA complex in Santa Olive between the 12th-16th March 2012. The materials presented in this document were the presentations/annotations that were used during this training week.

1.DRAFT ON-LINE MANUAL

1.1. Introduction

The DaCoTA Training Manual is an online tool which presents the DaCoTA in-depth road accident investigation methodology, primarily to in-depth road accident investigators. Its aim is to indicate the scope, characteristics and practical requirements of the methodology. It also contains detailed information on all variables (or data fields) in the DaCoTA database.

The on-line manual is currently under development and will be completed by December 2012. Access to the manual is currently restricted to the DaCoTA partners and the members of in-depth investigation teams who are working with the DaCoTA partners. The manual can be viewed directly through a web browser (see Figure 1). It is also linked to the DaCoTA online database system that is designed to record accident data. This will allow investigators to see individual variable definitions when completing or browsing the database.

The online manual is divided into 5 sections:

- DaCoTA Teams
- Variables
- Methodology Outline
- Detailed Methodology
- Forms and Documents

DaCoTA Teams section describes the Pan-European In-depth Accident Investigation Network and the structure of the investigation teams. This includes information on the level of team experience and individual roles and expertise. The Variables section provides a comprehensive list of approximately 1500 variables and their definitions that are possible to collect for during an accident investigation. Section 1.3 provides some additional information on the variables section however due to the large number of variables a full list is not provided in this document. The Methodology Outline gives an overview of the DaCoTA Methodology and gives an idea of the investigation requirements. A copy of the text from the online training manual can be found in Section 1.4. The Detailed Methodology section is the core text of the manual as it provides detailed information about how to collect data from road accidents, what equipment is required and what precautions should be taken by team members. The full Detailed Methodology Text is presented in Section 1.5. The Forms and Documents section contains a selection of accident investigation tools (forms, lists and diagrams) that can be effective in helping the investigator collect data in a structured and organised manner. Further details can be found in Section 1.6.

D2.3 Training Package including training manual and draft protocols

The figure consists of two screenshots of the DaCoTA online Manual. The top screenshot shows the main manual page with a table of contents and a search bar. The bottom screenshot shows the 'Methodology Outline' page with detailed text and a list of sub-topics.

DaCoTA Manual

- Introduction and Acknowledgements
- DaCoTA Teams
- Variables
- Methodology Outline
- Detailed Methodology
- Forms and Documents

Page last modified on December 20, 2011, at 08:29 AM

[▲ Top ▲](#) [Search](#) [Recent Changes](#) [All Recent Changes](#)

Search: [Go](#)

Methodology Outline

This section provides a brief overview of the DaCoTA in-depth road accident investigation methodology as developed by partners working in DaCoTA Work Package 2. The aim is to briefly indicate the intended scope, essential characteristics and practical requirements of the methods to be deployed. For a complete overview, this section should be read together with the section on DaCoTA Teams.

Essential items, or building blocks, of the methodology are listed to briefly define their intended scope and the type of method to be used for each item. Additionally noted, at the more practical level, are key items of equipment and any essential arrangements that must be put in place by investigating teams.

For the pilot study, which will run over April to June 2012, investigating teams will start with different levels of experience and their ability to complete the methodology will therefore vary. Items of methodology are defined for four levels of team experience, new, developing, experienced retrospective and experience on-scene teams.

This section, together with the section on DaCoTA Teams, is intended to be used by DaCoTA Network Team Leaders, as brief-outline to see what is required, ask any early questions, and start making plans as soon as possible.

This section is not intended to provide a detailed description of the methodology. Please refer to the [Detailed Methodology](#) section for further information.

- Sampling Plan
- Health and Safety
- Accident Notifications
- Scene and Road
- Vehicle Inspection
- Vulnerable Road User
- Behavioural Data
- Medical Data
- Accident Causation
- Accident Reconstruction
- Case Delivery

Page last modified on January 20, 2012, at 08:50 AM

[▲ Top ▲](#) [Search](#) [Recent Changes](#) [All Recent Changes](#)

Done Internet | Protected Mode: On 100%

Figure 1: Screen shots of the DaCoTA online Manual

1.2. DaCoTA Teams

The Pan-European In-depth Accident Investigation Network (the “Network”) is made up of investigating teams who are all based in a number of different European countries. Each investigating team has a Team Leader and investigators. The DaCoTA network, methodology and training are organised by the Core Team who are the partners in DaCoTA Work Package 2. Core Team member organisations will also operate investigating teams in their local areas.

DaCoTA Team Structure

All teams:

- A team should consist of at least two investigators.
- A team leader must be identified, the team leader can be one of the investigators.
- At least one of the investigators should have successfully completed the DaCoTA training course and be responsible for guiding others in their team.

New teams and Developing Teams:

- The team should have access to experts with knowledge of medicine, human factors, roads and vehicles.

Experienced teams:

- Specialists in road, vehicle and human factors should be integrated into the team.
- Immediate access to experts in medicine, accident causation and reconstruction is also necessary.

Equipment

All teams

Secure office space with computers and file storage, access to a vehicle and the DaCoTA training manual are required for all teams.

Arrangements

All teams

The team must consist of at least two members to perform challenging tasks in a safe and qualitative way. It is recommended to recruit team members from a range of relevant specialities. Arrange for at least one team member to attend formal DaCoTA training and organise dissemination to any additional team members within 2 weeks.

Data Collection and Case Analysis

The in-depth accident investigation process first requires investigators to make observations and gather information before going on to analyse the information to understand what happened and why. The methodology will therefore cover both the collection of data and case analyses. Data collection can involve a wide range of activities such as making notes, measurements, interviewing people, collecting injury details from hospitals, taking photographs and possibly making video recordings. Case analysis includes identifying and coding how and why events such as collisions

D2.3 Training Package including training manual and draft protocols

between road users or injuries to road users occurred, and more specific analyses are involved, for example to calculate vehicle speeds.

This section outlines the key methods investigators will need to follow to collect detailed data and photographs, and to go on to make the case analyses to reconstruct events and understand the causes of collisions and any injuries. Teams will upload the data, photographs and analysis results into an on-line database system.

Database Variables

The database system provides approximately 1500 variables (or fields) for data entry per case. However, it must be noted that only a sub-set of available fields will be relevant to any individual case (for example, variables defined for trucks will not be needed when there are only passenger cars involved in an accident). As an approximate guide, normally around 200 variables will need to be collected to describe the overall accident and road characteristics. In addition, around 200 to 300 variables will be completed for each vehicle involved. When it comes to the humans involved, a further 100 to 200 variables are required. The more experienced teams may need to consider entering information against further variables in order to record all observations and conclusions that have been made.

There are two different ways of working to gather information for accident investigations: on-scene and retrospective. It is possible to investigate accidents using one or a combination of both ways of working.

a) On-scene

On-scene work is carried out by accident investigators who arrive at the scene of the collision in time to record essential information before it is lost. On-scene working is the recommended way for teams to gather information to carry out the DaCoTA in-depth accident investigation methodology. Examples of information that an on-scene team will aim to gather quickly, include the rest position of vehicles, interviews with the road users and witnesses, light and weather conditions, and marks left on the road surface that may quickly fade. Previous work has shown the importance of arriving quickly after the incident has occurred to gather the information required to understand what has happened and why. As a guide for the DaCoTA methodology, teams should arrive at the scene no more than 30 minutes after the time when the collision occurred. This requires teams to have a good system for being notified of accidents quickly and consistently.

Depending on the size and type of road network to be covered, it may be necessary for teams to travel or work closely with their local emergency services in order to arrive in a safe and timely way. On-scene teams will, where possible, gather all necessary information during the on scene visit. However it may sometimes be necessary, for practical reasons, to supplement investigations with less urgent activities on a retrospective basis. It is also recognised that less experienced or less well established teams may not be able to work on-scene.

b) Retrospective

Retrospective work includes any investigation activities carried out after the scene has been cleared of the people and vehicles involved. Examples of retrospective working include examining vehicles at a garage / recovery yard, interviewing people over the telephone or by using a postal questionnaire, and visiting the road location hours or days after the collision occurred. Retrospective work can be a more practical

way to gather evidence that is not likely to move or change over time, and there are experienced and successful research projects that use only retrospective methods. Additionally, this method is a valuable way to supplement on-scene activities. It is also recognised that less experienced or less well established teams may only be able to work retrospectively. All teams are expected to have an organisation and combined expertise that will enable all DaCoTA accident investigation tasks to be completed

Team Experience

For the pilot study, investigating teams will start with different levels of experience and their ability to complete the methodology will therefore vary. Four levels of team experience are therefore considered here: new, developing and experienced retrospective and experienced on-scene teams. Discussions will be held with teams in the early stages of the Network activity to determine and agree each team's appropriate level of experience going into the pilot study. Teams are expected to develop during the pilot study and to work towards reaching the experience level necessary for any future work beyond DaCoTA.

a) New Teams

New teams are teams who have sufficient personnel, facilities and equipment to undertake the pilot study activities, but have little or no experience at making in-depth investigations. They will have some access to a range of specialists in the areas of vehicle, road and human safety related factors, but these personnel may not be directly involved as investigators. Teams will be expected to establish the necessary infrastructure, including local agreements to do the work, acquire information and receive accident notifications, but these activities will be finalized in the months leading up to the start of the pilot study, planned in April 2012. Personnel will require training and support from the core DaCoTA team in order to conduct the pilot study. New teams are encouraged to work on-scene, but it is recognised that working retrospectively may be advantageous until necessary permissions, training and experience are in place. New teams are encouraged to progress on to achieve "Developing Team" status by the end of the pilot study.

b) Developing Teams

Developing teams are teams who have sufficient personnel, facilities and equipment to undertake the pilot study activities and some experience at making in-depth investigations. They will have some experience with field work to study road or vehicle factors or to interview people, but this may not have been carried out for in-depth accident investigations. They will have some access to a range of specialists in the areas of vehicle, road and human safety related factors, but these personnel may not all be directly involved as investigators.

Developing teams will have some infrastructure in place, including local agreements to do the work, acquire information and receive accident notifications, but these activities may need to be finalized in the months leading up to the start of the pilot study, planned in April 2012. For some areas of the methodology, personnel will require training and support from the core DaCoTA team in order to conduct the pilot study. Developing teams must attempt to work on-scene, but it is recognised that only retrospective working may be possible for at least some case investigations. Developing teams are encouraged to build on existing skills and experience during the pilot study.

D2.3 Training Package including training manual and draft protocols

c) Experienced Retrospective Teams

Established retrospective teams are established in-depth accident investigation teams who work retrospectively. They are teams with a full range of knowledge and experience gained over a continuous operating period of at least two years. Experienced retrospective teams will have the well-established capability to be notified about accidents and to gather a broad range of data within around 5 days of the accident occurring. They will have at least 2 experienced team members who have investigated at least 50 in-depth accidents each. Teams will have agreements in place for access to all necessary police, hospital and other information required. Personnel will only require training for the purpose of gaining familiarization with DaCoTA project's specific aims and procedures. While experienced teams are encouraged to work on-scene at all times, it is recognised that this may not be possible under some local circumstances.

d) Experienced On-Scene Teams

Experienced On-Scene teams are established in-depth accident investigation teams who work on-scene. These teams will have a full range of knowledge and experience gained over a continuous operating period of at least two years. Teams will have the well-established capability to be notified about accidents and to travel onto the scene within around 30 minutes of the accident occurring. They will have at least 2 experienced team members who have investigated at least 50 in-depth accidents each. Teams will have agreements in place for access to all necessary police, hospital and other information required. Personnel will only require training for the purpose of gaining familiarization with DaCoTA project's specific aims and procedures. Only experienced on-scene teams have the capability to carry out the full investigation methodology in all accident investigations, as recommended by DaCoTA.

Methods

All teams

The team must consist of at least two members to perform challenging tasks in a safe and qualitative way. It is recommended to recruit team members from a range of relevant specialities. All teams are required to arrange for at least one team member to attend formal DaCoTA training and organise dissemination to any additional team members within 2 weeks.

This document describes the tasks of each investigator (by investigator role) involved in the DaCoTA project. Each task can be assigned to a DaCoTA accident collection shift or a DaCoTA case life cycle. A DaCoTA case life cycle starts with an accident notification that fulfils the sampling criteria and ends with the completion of all required entries in the DaCoTA database and publication of the case.

D2.3 Training Package including training manual and draft protocols

Below there is a list of all investigator roles in DaCoTA. The roles will be described further, later in this document

1. Team Leader
2. Case Leader
3. On-Scene Investigator
4. Retrospective Vehicle Investigator
5. Retrospective Accident Site Investigator
6. Interviewer
7. Road User Contact Questioner
8. DREAM Analyst
9. Reconstruction Analyst
10. Injury Mechanism Analyst

It is recommended that each team has at least two active investigators working each case, one of whom must be designated as the case leader. Investigators can take on more than one role within a case (e.g. the same person may conduct interviews, injury analysis and DREAM analysis). There is always only one Case Leader in a DaCoTA shift and case respectively, although there might be two or more persons working together with sufficient experience to be considered for the Case Leader role.

1. Team Leader

The team leader is the overall coordinator of a local investigation team. This person is identified at the point of application to join the DaCoTA network.

The Team Leaders responsibilities include:

- Recruitment and management of their investigation team
- Ethical and data handling agreements
- Nomination of case leaders
- Securing funding for the team where necessary
- Liaison with authorities, emergency services, recovery garages etc. to develop core infrastructure
- Reporting on team progress including accident notifications, time to investigation, case completion and training/support needs
- Conducting case review meetings with their investigation team
- Organising all necessary equipment for conducting investigations
- Arranging counselling for investigators where necessary
- Organising an investigation plan/schedule
- Final quality control of cases and upload to the shared DaCoTA database

D2.3 Training Package including training manual and draft protocols

- Reporting to DaCoTA WP2 Leader on investigation related issues

2. Case Leader

The DaCoTA investigation shift plan defines which person is the case leader on a specific shift. It is recommended that the case leader should be the most experienced team member on that shift. The Case Leader is in general responsible for the organization of the shift and the data collection and entry into the database for cases that are started during the shift.

Before and during the shift the case leader has the following tasks:

- Assign tasks between on-scene or retrospective investigators
- Check that all equipment is present and working
- Check if notified cases fulfil the sampling criteria
- Fill out the accident log

During a case investigation the case leader has the following tasks

- Crisis handling, if other investigators have physical or emotional issues which affect their ability to conduct the investigation
- Decide according to the sampling plan if accident data will be further collected if the accident site is already cleared up and neither police / rescue or accident participants are available
- Decide when the on-scene and retrospective data collection is finished

During the case life cycle the case leader has the following tasks

- Check the case status overview and identify issues in case completion
- Decide if a retrospective accident site investigation is necessary
- Liaise with all individuals contributing to the case
- Invite and conduct the case analysis meeting

3. On-Scene Investigators

It is recognised that new teams may not work on-scene during the DaCoTA pilot, but this is the recommended primary methodology. The DaCoTA investigation shift plan defines which persons are the On-Scene Investigators on a specific shift. The On-Scene Investigators are responsible for collecting the on-scene data for a DaCoTA case. If more than one person is scheduled the task split will be defined by the Case Leader.

Before and during the shift the On-Scene Investigators have the following tasks:

- Prepare the forms and writing materials for the shift
- Check own equipment, including cameras, measuring and marking equipment

During a case investigation the On-Scene Investigators have the following tasks

DaCoTA_D2_3_training materials_Final.doc

D2.3 Training Package including training manual and draft protocols

- Talk to police, fire brigade, witnesses and road users involved in the accident and prepare for follow up interviews
- Take photos of the accident location and vehicles, identify and highlight fast changeable marks and traces
- Measure all relevant parameters of the accident scene and prepare scene sketch or photogrammetry
- Fill out the vehicle forms and conduct inspection of involved vehicles as per the DaCoTA training
- Fill out the accident site form and prepare a hand drawing of the accident scene, check for restriction in visibility and weather conditions
- Fill out the road and lane forms

After a case investigation the On-Scene Investigators share the following tasks:

- Check petrol and equipment in the investigation car

During the case life cycle the On-Scene Investigators have the following tasks:

- Complete all relevant forms and upload the data to the local database
- Select on-scene photos, sanitise (blur faces, street names, logos etc.) and upload the photos to the database

4. Retrospective Vehicle Investigators

The DaCoTA investigation shift plan defines which persons are the retrospective vehicle investigators on a specific shift. Retrospective investigation is necessary if it was not possible to conduct a full investigation on-scene. The retrospective vehicle investigators are responsible for collecting vehicle data after an accident involved vehicle has left the scene. If more than one person is scheduled the task split will be defined by the vehicle investigators themselves.

Before the investigation the retrospective vehicle investigator has the following tasks:

- Prepare the forms and writing materials for the vehicle investigation
- Check own equipment, including cameras, measuring and marking equipment

During the investigation the retrospective vehicle investigators have the following tasks:

- Take photos of the accident involved vehicle(s)
- Measure all relevant damage to the vehicle(s)
- Fill out the vehicle investigation form (s)

After the investigation the retrospective vehicle investigators have the following tasks:

- Check for petrol and equipment in the investigation car

During the case life cycle the retrospective vehicle investigators have the following tasks:

- Complete all relevant forms and upload the data to the local database

D2.3 Training Package including training manual and draft protocols

- Select vehicle photos, sanitise (blur licence plates, company names/logos) and upload the photos to the database

5. Retrospective Accident Site Investigators

The case leader together with the team leader decides which team members are the retrospective accident site investigators (where required) to collect site data after the accident has been cleared. (This is a road engineer type role). Before the investigation the retrospective accident site investigators have the following tasks:

- Prepare the forms and writing materials for the vehicle investigation
- Check own equipment, including cameras, measuring and marking equipment

During the investigation the retrospective accident site investigators have the following tasks:

- Take photos of the accident site and approach of the involved vehicle(s)
- Measure all relevant parameters of the road and environment
- Fill out the road form(s)

After the investigation the retrospective accident site investigator has the following tasks:

- Check for petrol and equipment in the investigation car

During the case life cycle the retrospective accident site investigator has the following tasks:

- Complete all relevant forms and upload the data to the database
- Select site photos, sanitise (blur licence plates, street names, company names/logos) and upload the photos to the database

6. Interviewer

The case leader together with the team leader decides which person(s) is/are the Interviewers for a specific case. It is recommended where possible that the interviewer should have some background in human factors, psychology or a related discipline. It is expected that experienced teams have such an interviewer. The interviewer(s) is/are generally responsible to organize the interview(s) for relevant persons in a DaCoTA case. If more than one person is required to be interviewed at the same time the task split will be defined by the interviewers themselves.

The interviewer has the following tasks:

- Gain written consent for interviews where necessary
- Prepare and conduct the interviews (on-scene and/or retrospectively, face to face and/or on the phone)
- Fill out the interview forms
- Store the interview data in line with local data handling agreements

D2.3 Training Package including training manual and draft protocols

- Liaise with other investigators regarding core findings
- Ensure core interview findings are reflected in the case as entered onto the database

Where teams choose to collect road user data through questionnaires, a team member will need to be designated who takes responsibility for the following tasks:

- Manage questionnaire materials
- Send out questionnaires (and where appropriate reminders) to contacts identified by the investigation team
- Securely store questionnaires
- Transcribe appropriate questionnaire data to the database and liaise with other team members regarding core findings

7. Dream Analyst

The case leader together with the team leader decides which person(s) is/are the DREAM Analysts for a specific case. The DREAM analyst(s) is/are responsible for organizing the DREAM analysis for relevant persons in a DaCoTA case. If more than one person is scheduled the task split will be defined by the DREAM analysts themselves.

The DREAM analyst has the following tasks:

- Prepare and conduct the DREAM analysis
- Fill out the DREAM analysis forms
- Enter the DREAM analysis on the database

8. Reconstruction Analyst

This role should be integrated into all developing and experienced teams. New teams must collect data that an external reconstruction analyst could use, but are not expected to complete their own full reconstructions. The reconstruction analyst is generally responsible for the reconstruction of a DaCoTA case. The reconstruction analyst has the following tasks:

- Quality check the data collected for reconstruction – review with investigators where necessary
- Prepare and conduct the accident reconstruction
- Enter the reconstruction analysis into the DaCoTA database

9. Injury Analyst

This role should be integrated into all developing and experienced teams. New teams must collect data that an external injury analyst could use, but are not expected to complete their own full injury analysis. The injury analyst is generally responsible for

D2.3 Training Package including training manual and draft protocols

coding the injury data using the AIS method, and the individual causes (mechanisms) of each injury – as suggested by the evidence and in discussion with the investigators of each DaCoTA case.

The Injury Analyst has the following tasks:

1. Collect injury information
2. Code injury information according to the Abbreviated Injury Scale (AIS) 2005 (Update 2008)
3. Invite and conduct injury analysis meetings with investigators where necessary
4. Enter the injury data on the DaCoTA database

1.3. Variables

The Variables section provides a comprehensive list of approximately 1500 variables and their definitions that are possible to collect during an accident investigation. A set of core variables will be mandatory to be collected for all teams with additional variables being collected as the team gains experience. No one accident case would ever contain all of the variables as many relate to a specific type of road user and/or accident. It is intended that the variable list and definitions will continue to be developed and added to in the future. The variable section includes notes about how to collect the necessary information when investigating accidents but they are intended to be considered alongside the more detailed methodology guidelines provided in the other sections of the on-line manual. Variables can be viewed directly through a web browser however viewing variables through the database system is the best way of identifying groups of variables. The following list illustrates the categories of variables included in the manual. A brief description of the type of variables included in each category is given in brackets by way of an example.

- **Accident** (Date of accident, weather conditions)
- **Road** (Road layout, speed limit)
- **Road User** (age, injury severity)
- **Element** (Information relating to the investigation e.g. date of site inspection)
- **Vehicle** (general condition, general damage)
- **Car** (safety technologies fitted, number of seats)
- **Truck** (Mirror type, underrun protection)
- **Bus** (Emergency exits, number of occupants)
- **Other** (miscellaneous)
- **Seat** (Belt information, position)
- **Airbag** (Damaged, activated)
- **Wheel** (Tyre depth, make)
- **Analysis** (Deformation measures, calculations)
- **PTW** (Rider clothing, make/model)
- **Photo** (information to capture)
- **Reconstruction** (Whether performed for case)
- **Dream** (Accident causation analysis)

1.4. Methodology Outline

The methodology outline section provides a brief overview of the DaCoTA In-depth road accident investigation methodology as developed by partners working in DaCoTA Work Package 2. Items of methodology are defined for four levels of team experience; new, developing, experienced retrospective and experienced on-scene teams. Extended explanations for these items are outlined in the draft online manual section.

The aim of this section is to briefly indicate the intended scope, essential characteristics and practical requirements of the methods to be deployed. For a complete overview, this section should be read together with the section on DaCoTA teams (Section 1.2). Essential items, or building blocks, of the methodology are listed to briefly define their intended scope and the type of method to be used for each item. Additionally noted, at the more practical level, are key items of equipment and any essential arrangements that must be put in place by investigating teams.

For the pilot study, which will run between April to June 2012, investigating teams will start with different levels of experience and their ability to complete the methodology will therefore vary. Items of methodology are defined for four levels of team experience; new, developing, experienced retrospective and experience on-scene teams.

This section, together with the section on DaCoTA teams, is intended to be used by the DaCoTA network team leaders, as a brief-outline to see what is required.

1. Sampling Plan

The purpose of the sampling plan is to create a method of investigation that will be broadly representative for coverage of various accidents types occurring across participating states, within the practical limitations imposed by the pilot study. For future investigations, beyond DaCoTA, the purpose of the sampling plan is to make on-scene investigations that closely represent all types of traffic accidents occurring on the public roads of Europe, adequately covering all hours of the day, all days of the week and all levels of injury severity.

All teams

The DaCoTA pilot study investigation teams should produce at least five cases, covering a range of different types of crashes (e.g. different crash configurations, vehicle types, road users and levels of injury severity). At least one case should involve a moving motor vehicle or pedal cyclist on a public road. Accidents selected may include fatal, seriously injured, slightly injured or non-injured road users. At least 3 out of 5 cases must include a road user who was taken to hospital immediately after the accident.

Accidents selected may include trucks, buses, cars, powered two wheelers, pedal cycles, pedestrians or other types of road users. The sampling area should have a clear geographical boundary in which the team has a high probability of obtaining all necessary information.

The resulting sample can be compared with police recorded accident data across Europe (CARE database), especially by use of the accident-type and other variables to be recorded in the same way for both DaCoTA and CARE (as CADAS Glossary v3.11).

D2.3 Training Package including training manual and draft protocols

On-scene Teams

The geographical boundary of the sampling area must give a high probability that the team will arrive on the scene in time to capture all essential information, especially to capture information that is quickly lost (as a guide, teams should arrive no more than 30 minutes after the time when the collision occurred where possible).

If more than one accident occurs at the same time, the team must investigate the accident which they received the notification from first. A case cannot be included unless there is at least one vehicle or at least one road user or witness still at the scene when the team arrives. However, in some exceptional situations, a case may be included without any vehicles or road user's present on-scene if there are other sources of reliable information allowing adequate conclusions to be drawn about the circumstances and causes of the accident.

All teams are to go on-scene as described above. In addition, the sample will closely represent all types of traffic accidents occurring on the public roads, adequately covering all hours of the day, all days of the week and all levels of injury severity.

All teams

Investigation teams should examine local accident statistics before the study commences to identify a suitable sample region with accident types broadly matching accidents occurring over the whole country and provide these findings in a report together with a description of the sampling procedure to be used.

Furthermore, investigation teams should establish a fast and reliable system that will notify the team when accidents occur (please refer to the Accident Notifications section).

2. Team Safety

To ensure all teams have the knowledge, equipment and support necessary to work safely.

All Teams

All of the teams must complete the following items for team health and safety requirements;

- Complete a full risk assessment.
- Train investigators in health and safety specific to vehicle examination
- Provide investigators with appropriate personal protective equipment (PPE).
- Ensure investigators have appropriate inoculations
- Road and on-scene investigators should be trained in health and safety at accident scenes, including working in live traffic conditions, team-vehicle positioning and giving first aid.
- Maintain a record of any team incidents.

All Teams

It will be the team leaders' responsibility to ensure all local health and safety regulations and requirements are met:

D2.3 Training Package including training manual and draft protocols

- Health and safety training.
- Counselling availability.
- Inoculations (e.g. Hepatitis-B and tetanus are recommended).
- Retrospective teams training to work safely alongside live traffic conditions
- On-scene Teams should have training on coning out roads/managing live traffic and parking project vehicles in fend-off position.

3. Accident Notifications

The purpose of the accident notifications section is to ensure that investigation teams are aware of the accidents as they are occurring. Furthermore, it is valuable to ensure that the teams are meeting their sampling criteria in a timely manner and are able to monitor and report sampling rates.

It is important to ensure that the accident notification information adequately identifies all accidents that meet the sampling criteria. Also, the alarms must provide detailed information on the location of the accident.

Teams must record notifications about all accidents occurring in the sample region during the pilot study and note which accidents were accepted and rejected, and the reasons why. The accident notification data should be used to produce a brief report at the end of the pilot study.

Investigation teams should also consult the sampling plan to determine whether the accident notifications are meeting the sampling criteria. Accident notification should be received within 24 hours of the accident occurrence to allow the team adequate time to collect as much of the remaining information from the scene of the accident as possible.

For on-scene investigations, instant notification (e.g. by e-mail, two-way radio, SMS, etc.) from the police or other emergency services when an accident occurs are required to enable the team to reach the scene of the collision before it is cleared.

Experience has shown that real-time accident notification information can lack important details. Some teams may therefore need to go on-scene to determine if accidents are to be investigated without knowing beforehand whether they fit within the sampling plan requirements (i.e. if the accident on a public road, road user hospitalisation status, if vehicles or road users are on-scene, etc.).

4. Scene and Road

For each accident it is necessary to take photographs of the road layout, sightlines, skid marks, contact marks, point of collision, rest positions of vehicles and parts in order to collect data that describes the scene for each accident, including the road layout, vehicle positions and where possible transient data such as skid marks and environmental conditions, to a level that will allow case analysis and reconstruction.

It is also necessary to take measurements of road layout and markings showing paths taken by road users before and after collision to make a scaled sketch of the accident later. Adequate photographs of approaches to the point of collision are also required. Additionally, if possible, make video recordings. Record other road data (e.g. type and position of signs or safety rails or fences).

D2.3 Training Package including training manual and draft protocols

Determine the type of collision that has occurred and code using the accident-type coding system.

Find safe parking. Search for marks and traces and identify the exact position of the accident. Contact the person in charge at the accident scene to get information on circumstances and participants. Make sure not to hinder the rescue or police investigation. Identify priorities for taking measurements and photographs.

In support of vehicle and human factors methodology: make a quick inspection of vehicles to catch transient data such as weather and road conditions, vehicle positions, debris, loads, leakage and trailers. Talk to police, rescue services, involved road users and witnesses to collect contact information.

Back at the office open the case in the database system and enter a minimum set of variables without delay, quality check of data, entering full data into the system (database) and draw a scaled scene sketch.

All Teams

- Obtain permission from authorities to be on-scene.
- Hand out information leaflets about the research project.
- Get road users to fill in consent forms (if and when required locally).

5. Vehicle Inspection

It is necessary to collect data that describes all types of vehicles involved in each accident, including specification, condition, damage, safety equipment performance and occupant information, to a level that will allow case analysis and reconstruction. This item also includes the investigation of children in cars, especially the use of child restraints (please also refer to the Vulnerable Road User section).

For the vehicle inspection:

- Take photographs of the vehicle exterior and interior according to the photo routine.
- Measure and collect data for exterior and interior variables.
- Search for clues to understand:
 - Pre-crash distractions such as food, phone, etc.
 - In-crash information such as roll direction, passenger kinematics and contact marks from collision objects. Seat belt use and cause of injuries to occupants (inside) and vulnerable road users (outside).
 - Collect child restraint information such as type of restraint, usage and damage.
 - Post-crash information such as rescue damage.
- Make sure to follow the safety routines (Item 3).
- Locate the vehicle and, where necessary, gather approval from vehicle owner and repair shop/recovery yard for vehicle inspection.
- Collect basic vehicle data at the office before leaving for inspection.

D2.3 Training Package including training manual and draft protocols

- If possible and necessary move the vehicle to get more working space around it.

With appropriate permission, on-scene teams are to record key transient information that will not be seen retrospectively (e.g. pedestrian swipe marks on the bonnet, paint transfer between vehicles or tyre pressures).

Completing the vehicle inspection can be done on-scene or retrospectively at the repair shop/recovery yard with approval from the vehicle's owner.

Experienced Teams

Are required to do an advanced examination of vehicle damage and safety systems.

All Teams

- Inspections should be performed by two trained investigators.
- It is useful to establish agreements to examine vehicles with relevant organisations (e.g. vehicle recovery or repair companies/organisations or government/police vehicle-examiners).

6. Vulnerable Road Users

The purpose of the Vulnerable Road User section is to collect data that describes all vulnerable road users (VRU) (pedestrians, motorcyclists, pedal-cyclists) involved in the accident, including their role in the accident causation, sources of injury, whether they were equipped with protective clothing, a record of any contact marks and other related scene evidence.

All Teams

- General vehicle examination for motorcycles (Powered two wheelers) and pedal-cycles.
- Identification of vehicle safety features (ABS, Traction Control, Adaptive lights).
- Examine if tyres or rims (and other vehicle parts) were damaged due to the accident, checking for scrapes marks and cracks.
- Check if the upper protective system integrates an airbag or neck protection

Experienced Teams

- Examination of the PTW for motor power enhancement
- Inspect the fuel management system for enhancement
- Evaluation of the effectiveness of systems such as brakes and suspension.

All Teams

- In addition to scene/road examinations (item 5), examine and record approach paths for PTWs, pedestrians and bicyclists, and take measurement, such as throw distances and skid marks at scene.
- Look for evidence of locked wheels on tyres
- Exterior contact marks from VRU's on opponent vehicle.
- Look for helmet damage caused in the accident.

D2.3 Training Package including training manual and draft protocols

- Examination of helmets, body armour and protective clothing.
- Examine if helmets and visors were certified for PTW use.

Developing Teams and Experienced Teams

- In addition to injury coding described in medical data, identify the body regions that contacted the other vehicle or object on the road.

Experienced Teams

- Examine the protective equipment (helmets and clothing) to assess impact performance
- Examine if the personal protective equipment was fitted correctly and worn in the correct place
- Please refer to the vulnerable road user section of the equipment List for the vulnerable road user equipment list.

All Teams

Need to have at least one team member trained in collecting VRU specific variables

Experienced Teams

Should have a PTW specialist on team

7. Behavioural Data

The purpose of collecting behavioural data is to collect data (mainly from interviews/questionnaires) to understand and describe road user behaviour and relevant background information in support of the overall accident analysis. Interviews are the main method for collecting road user behavioural data but all data collection can give information valuable for evaluating road user behaviour. Interview material should be stored locally and be as complete as possible for later re-analysis by the team, if local laws and guidelines allow. Database entries need to be made fully anonymous, without any personal names, addresses or vehicle registration numbers included.

The following sections and bullet points are a list of measure that teams collecting on scene or retrospective behavioural data need to complete.

On Scene

- Contact the crash participant on-scene, if possible, to ask questions concerning the course of events and possible causes of the accident.
- Conduct a full interview according to a semi structured form to be conducted as soon as possible, on-scene, at hospital, or retrospectively by phone/face to face.

On Scene and Retrospective

- Interviews should be conducted as soon as possible after the accident and if possible face to face.

D2.3 Training Package including training manual and draft protocols

- As it is not always possible to conduct an interview on-scene, the methods recommended here are to be tried in the following order
 1. On-scene interview
 2. Interview at hospital
 3. Retrospective interview face to face or by phone
 4. Postal questionnaire

All Teams

- Check national legislation and guidelines for possibility to process potentially sensitive personal findings as anonymised data.
- Obtain ethical approval if necessary.
- Give consent forms to perform interview(s) if needed.
- Each team needs investigator(s) trained in conducting interviews.

8. Medical Data

The purpose of collecting medical data is to collect and code injury data (according to the Abbreviated Injury Scale), perform injury mechanism analysis, to classify accidents by medical injury severity and allow analysis on the potential for injury reduction. Database entries are to be made fully anonymous, without any personal names, addresses or vehicle registration numbers included.

All Teams

- Note Police recorded injury severity for each person involved.
- Attempt, with permission, to collect medical records from hospitals or other appropriate sources (e.g. pathologist or doctors) and describe the injuries.
- Follow all necessary ethical and data protection procedures both in the acquisition, processing and storage of any information on both paper or electronic media.

Developing and Experienced Teams

- Code injuries according to AIS 2005 (update 2008) manual by trained medical personal.
- Carry out a case by case analysis of the possible mechanisms or causes of injuries.

All Teams

- Obtain ethical approval if necessary.
- Consent forms to obtain medical records including routines on how to send and receive these forms.
- Obtain an agreement with local hospitals to access medical records.

D2.3 Training Package including training manual and draft protocols

Please note: the DaCoTA training programme will cover the collection and basic description of injuries, but will not be able to provide authorised AIS training. Additionally, it is recommended that at least one investigator from each team should receive official AIS training and acquire the necessary manual. A list of authorized training organisations can be provided upon request.

Experienced Teams

- Fully trained and experienced medical personnel for AIS coding and analysis of the causes of injuries.

9. Accident Causation

The purpose of the Accident Causation is to use the DREAM methodology to analyse and code the cause of each accident in a uniform and comparable way. The Driving Reliability and Error Analysis Method (DREAM) was first developed by Michael Ljung-Aust and later developed in the EC SafetyNet project to make it possible to systematically classify and store accident causation information which has been gathered through in-depth investigations by providing a structured way of sorting the causes behind the accident into a set of formally defined categories of contributing factors. The methodology has since been further developed, including updates for use in the DaCoTA project.

Methods

All Teams

- When all relevant pre-crash information is collected the DREAM method is used for categorising contributing factors.
- Reconstructions can validate the result.
- One DREAM analysis is completed for each road user such as driver, powered two wheeler rider (driver), pedal-cyclist and/or pedestrian (not passengers) regardless of blame.
- Enter the DREAM codes in the database system.

10. Accident Reconstruction

The purpose of reconstructing the accident is to utilise all available evidence to best analyse and reconstruct the accident in order to calculate vehicle impact speeds and evaluate the sequence of events.

All Teams

- Assure that data needed to perform reconstructions is available, such as a scaled sketch, pictures and a coded sequence of events.
- Complete basic calculations on braking and skidding distances etc.
- Consider using other information sources such as the police.

Developing and Experienced teams

- Collect more specialized data collection

D2.3 Training Package including training manual and draft protocols

- Carry out specialized calculations, including energy based reconstructions (calculating the change of velocity from vehicle damage).

Experienced teams

- Carry out full momentum based reconstructions by software.

All Teams

- Training and support from the DaCoTA partnership.

Explore the possibility to view scene plans and results calculated by other local reconstruction experts, e.g. police experts (while maintaining the independence of the research study).

11. Case Delivery

To coordinate all case findings to ensure the team fully complete and enter all data and other materials onto the web-based database, and ensure cases have been subject to adequate quality control.

All Teams

- A case leader is appointed for each accident investigated. The case leader is responsible for the completeness and the quality of the case inserted. The case leader has to open the case, in the database system, on the day of data collection, whenever possible.
- The web-based database will check some data elements at the data entry stage.
- Database entries including pictures have to be fully anonymised without any personal names, addresses or vehicle registration numbers included.
- The database system will not allow incomplete cases to be submitted as completed (a core set of data has to be inserted before the case can be completed).
- Ensure that all necessary data elements and photographs may be uploaded into the shared database area to be seen by other members of the network.
- Any local requirements for data sharing or ethical agreements must be put in place before the pilot study commences.
- Identify a local IT technician able to install and maintain operation of the DaCoTA database system (technical advice will be available from the technical experts in the DaCoTA team).

1.5. Detailed Methodology

This section provides a detailed description of the DaCoTA in-depth road accident investigation methodology as developed by partners working in DaCoTA Work Package 2. The aim of the detailed methodology is to describe the intended scope, characteristics and practical requirements of the methods to be deployed.

Essential items of the methodology are listed to define their intended scope and the type of method to be used for each item. Additionally noted, at the more practical level, are key items of equipment and any essential arrangements that must be put in place by investigating teams. This section is intended to be used by DaCoTA network team leaders to see what is required, ask any early questions, and start making plans as soon as possible.

Investigation teams will differ in level of experience (e.g. new, developing and experienced). Furthermore, the investigators will also sometimes be divided into on scene and retrospective teams. For these reasons, some methodology sections are only relevant to certain teams. The detailed methodology attempts to detail a complete methodology, covering all teams. Investigation teams should refer to the applicable methodology outline section as the methodology outline is divided by level of experience and on scene/retrospective teams. This should enable teams to determine the methodology that applies to their requirements. The structure of the detailed methodology can be seen below:

- 1. Sampling Plan**
- 2. Health and Safety**
- 3. Accident Notifications**
- 4. Photo Routine**
- 5. Scene and Road**
 - a. Scene Measurements**
 - b. Scene and Road Sketch**
- 6. Vehicle Inspection**
- 7. Vulnerable Road User**
- 8. Behavioural Data**
 - a. Interview Guidelines**
 - b. Draft Telephone Interview Script**
- 9. Medical Data**
 - a. Coding Injuries**
 - b. Coding Injury Causes**
- 10. Accident Causation**
- 11. Accident Reconstruction**
- 12. Case Delivery**
- 13. Equipment List**

1. Sampling Plan

The purpose of the sampling plan is to create a method of investigation that will be broadly representative for coverage of various accidents types occurring across participating states, within the practical limitations imposed by the pilot study. For future investigations, beyond DaCoTA, the purpose of the sampling plan is to make on-scene investigations that closely represent all types of traffic accidents occurring on the public roads of Europe, adequately covering all hours of the day, all days of the week and all levels of injury severity.

All teams

- The DaCoTA pilot study investigation teams should produce at least five cases, covering a range of different types of crashes (e.g. different crash configurations, vehicle types, road users and levels of injury severity).
- At least one case should involve a moving motor vehicle or pedal cyclist on a public road. Accidents selected may include fatal, seriously injured, slightly injured or non-injured road users. At least 3 out of 5 cases must include a road user who was taken to hospital immediately after the accident.
- Accidents selected may include trucks, buses, cars, powered two wheelers, pedal cycles, pedestrians or other types of road users. The sampling area should have a clear geographical boundary in which the team has a high probability of obtaining all necessary information.
- The resulting sample can be compared with police recorded accident data across Europe (CARE database), especially by use of the accident-type and other variables to be recorded in the same way for both DaCoTA and CARE (as CADAS Glossary v3.11).

On-scene Teams

- The geographical boundary of the sampling area must give a high probability that the team will arrive on the scene in time to capture all essential information, especially to capture information that is quickly lost (as a guide, teams should arrive no more than 30 minutes after the time when the collision occurred where possible).
- If more than one accident occurs at the same time, the team must investigate the accident which they received the notification from first. A case cannot be included unless there is at least one vehicle or at least one road user or witness still at the scene when the team arrives. However, in some exceptional situations, a case may be included without any vehicles or road user's present on-scene if there are other sources of reliable information allowing adequate conclusions to be drawn about the circumstances and causes of the accident.
- All teams are to go on-scene as described above. In addition, the sample will closely represent all types of traffic accidents occurring on the public roads, adequately covering all hours of the day, all days of the week and all levels of injury severity.

All teams

- Investigation teams should examine local accident statistics before the study commences to identify a suitable sample region with accident types broadly

D2.3 Training Package including training manual and draft protocols

matching accidents occurring over the whole country and provide these findings in a report together with a description of the sampling procedure to be used.

- Furthermore, investigation teams should establish a fast and reliable system that will notify the team when accidents occur (please refer to the accident notifications section).

2. Health and Safety

Purpose/Aim

All who participate in the investigation of traffic accidents in DaCoTA must have the knowledge and equipment to be able to conduct these investigations in a safe manner. The purpose of this section is to provide all investigators with information on how to perform investigations in the safest possible way at an accident site. All investigators who work with accidents in DaCoTA must have read and know this routine. Team leaders have a duty, so far as is reasonably practicable, to ensure the health, safety and welfare of their team.

Each team member has a duty to co-operate with his or her team leader and to take reasonable care of their own safety and that of others who may be affected by their acts or omissions at work. Team members should notify the team leader of any shortcomings in the health and safety arrangements so that the team leader can take such remedial action as may be needed. In order to meet this requirement it is necessary for each individual to observe safe working practices at all times, and to be aware of any potential hazards, risks or dangers which are present, or may arise, in the course of their duties. Personal safety is paramount, if a situation develops, personal security must take priority over all else.

Travelling to the Scene of an Accident

The vehicle used for on scene investigations should ideally be equipped with warning lights on the roof and high visibility reflective material on the body. The lights may be used when they are needed to improve safety for the investigators or other road users by enhancing visibility and acting as a warning (please check for local laws/guidelines in your country regarding light colour and acceptable use). Unless you have an emergency services vehicle, driven by appropriately trained and authorised emergency services personnel, then local speed limits must be adhered to at all times. The driver must have a valid driving licence and insurance (insurance should usually be provided by the employer).

The vehicle should be kept in a safe, legal and roadworthy condition. It must not be loaded over its design carrying weight and tyre pressures must conform to the vehicle loading. All equipment must be evenly distributed and restrained where necessary. No load should be placed or carried on the back seat of the vehicle and if possible, loose items should be stored in a closed container in the rear of the vehicle. If using a saloon car then all equipment should be stored in the boot. If using an estate car or van then a suitable load restraint must be fitted. Emergency equipment must be kept readily available (e.g. first aid kit, fire extinguisher, torches).

The driver and passengers must wear their seatbelts at all times while in the vehicle and try to avoid carrying large items in pockets while restrained. If using a handheld video camera in the front passenger seat, then consider disabling the front passenger airbag. In the case of adverse weather conditions, if the driver or other

D2.3 Training Package including training manual and draft protocols

team members do not feel comfortable travelling, the driver should either slow down to an appropriate speed or the job should be abandoned. If the driver feels over tired, ill or unfit in any other way they must not drive.

Arrival On-Scene and Scene safety

There must always be at least two investigators working at an accident site. One of the investigators is the case leader and is in charge of the investigation team. The first thing to be done when an investigation team arrives at an accident site is for the case leader to assess the situation and whether it is possible to work safely. If the accident site is regarded as too dangerous, the investigators must not stop but keep on driving. If possible, the investigators should stop nearby and wait and see if the situation improves, e.g. if emergency services take control of the accident site and manage the traffic. If the accident site is regarded as safe, then the vehicle should be parked safely and in such a way that it does not hinder the entrance and exit of emergency vehicles. Team members should not open the vehicle doors while it is still moving.

The driver and passengers should be able to exit the vehicle without walking directly into a live carriageway. At an accident site, the vehicle should preferably be parked in front of a heavy vehicle (such as a fire engine), in a restricted area or at least ahead of police vehicles. If possible the vehicle should be parked at an angle with the front wheels turned so the vehicle does not continue straight ahead if it is hit. When parked, the vehicle should preferably be locked.

The next thing to do is make contact with the rescue services commander or police. The investigators should introduce themselves, check where they are allowed to work, ask about any restrictions and make sure that the DaCoTA vehicle is not parked so it interferes with rescue operations. Teams should consider the use of two-way radios to stay in contact when working on a large scene. It is recommended that all team members will have a key to the vehicle while on shift – for safety, convenience and to maintain access to equipment. All team members should carry and use torches at night – batteries should be checked at the beginning of each shift. There may be flammable liquids on scene. Do not smoke at the crash scene and be aware of others smoking i.e. bystanders or others involved in the collision. Also be aware of fumes on scene, particularly from exhaust emissions. Teams should try to ensure that where possible they move around the scene (even rotating roles) and take breaks away from areas where fumes may be particularly high. When noisy equipment is in use, team members should consider wearing ear defenders.

If at any time any team member feels unsafe or threatened (and this cannot be resolved immediately) then the team should stop the investigation and leave the scene (this also applies to post-crash scene visits, retrospective interviews and vehicle follow ups). Personal safety is paramount, if a situation develops, personal security must take priority over all else including the collection of equipment used on scene.

Making the Site Safe

Teams should always be aware of the risk of moving traffic, and the possibility of further vehicles intruding into the accident scene. Vehicles parked in 'fend-off' position (at an angle which deflects away from the scene) provide some protection. Where appropriate, the team leader should discuss with police whether the road, or part of the road can be closed to traffic. The team should place cones and signs where appropriate (where the road is still at least partially open and has not been

D2.3 Training Package including training manual and draft protocols

coned out by other services attending). Cones should be placed ahead of the first emergency service vehicle (in a fend-off position) and be staggered from the nearside kerb (or offside kerb if the situation occurs) to a safe width into the road.

The cones should be placed out from the “front” of the crash scene rearwards. This protects the person coning out, as they are placed within the coned-off area heading forwards. Similarly, when retrieving the cones, the person collecting them in should start at the rear of the scene and walk forwards; again this is to protect them from walking in live traffic. Emergency lights should be set up if required. If necessary, have someone alerting oncoming traffic ahead of the potential danger of the team working on the road.

If the scene is contaminated with any hazardous substances then the DaCoTA team should stay well clear until the area is deemed safe by fire services. Also be alert to the risk of electric shock. Consider carefully the positioning of electrical goods, and keep them out of direct rain. Electrical equipment must be maintained and tested by the authorised service agent according to national safety requirements. If running cables, also try to avoid creating trip hazards. Investigators should familiarise themselves with the site, checking that the ground is clear and consider using illumination where necessary. Before moving any debris, ensure that its position is measured and photographed, and check with police at the scene that it does not need to be left in place as evidence.

Team members should not risk their health to assist with moving damaged vehicles. When examining vehicles on scene, where possible, always exit and enter vehicles and deal with occupants from the side away from the live traffic lane (if the road has not been closed). If possible, do not work in a live traffic lane. If unavoidable, use another team member as look out whilst carrying out work – they should do no other task while acting as look out. Also consider using two way radios to alert each other of potential hazards. Be aware of the potential risk of personal injury from airbags and pretensioners. Do not tamper with undeployed airbags or pretensioners. Do not work directly in front of an undeployed airbag and keep fingers clear of pretensioners.

Always assess the stability of a vehicle (and any load) before investigation – Seek safety advice if the vehicle or its load seems unstable - if it is not safe do not risk your health to examine it.

Ensure the vehicle handbrake is properly applied and ignition switched off (be aware of preservation of evidence, if unsure check with the police at the scene). Investigators should always liaise with police officer in charge before moving or destroying evidence in and around the vehicle.

Wear suitable protective clothing to avoid contamination by oils, fuel, greases etc., pay particular attention to wearing thick protective gloves and kneepads/protectors when working around broken glass and jagged metal edges. Try to avoid direct contact with sharp surfaces where possible.

Loose debris and fluid around vehicles can cause damage to the eyes. Investigators should wear eye protection (goggles/safety glasses) which will also help to prevent accidental contamination of their eyes by rubbing. Remember that some parts of the vehicle may still be very hot – such as the exhaust. Try to wait for such parts to cool and wear thick protective gloves when handling. Be particularly cautious when dealing with fire damaged vehicles due to the serious contamination risk.

D2.3 Training Package including training manual and draft protocols

Be aware when examining vehicle components for the risk of injury due to unexpected operation of the item being examined or tested. Again, use protective gloves and goggles and liaise with other on scene services for advice where appropriate.

Fire

It is recommended that a fire extinguisher should be carried in the project vehicle. In the case of an uncontrolled fire, risks include burns, smoke inhalation and explosion. The DaCoTA team should immediately evacuate the area. After a vehicle has caught fire there is a risk of injury from hot vehicle parts. The team must wait for the vehicle to cool down. After a burnt out vehicle has cooled there is still a contamination risk from hydrofluoric acid – which is released at high temperatures from the rubber-like materials used for many gaskets, O-rings and seals. Hydrofluoric acid is very toxic and can cause severe burns. Impermeable gloves and goggles must be worn for examination of burnt out vehicles. Contaminated gloves must be safely disposed of. It is very important to ensure there is no skin contact with hydrofluoric acid. If a person believes they have been contaminated then affected clothing should be removed and the body areas involved washed thoroughly with water. All persons suspected to be contaminated must be taken to their nearest hospital as quickly as possible. Teams should also be aware of the risk of electrical fire and under no circumstances should a battery be reconnected once it has been disconnected.

At most investigations, teams will be speaking directly with members of the public. Where possible, they will be talking to the accident involved road users and any available eyewitnesses about the circumstances of the collision. They may also need to direct other road users away from the scene and respond appropriately to questions from bystanders. Investigators should be professional and courteous, but should be aware that tensions can run quite high at accident scenes and they may sometimes be faced with high levels of emotion, and even aggression. If at any time they feel under threat they should remove themselves from that situation and ensure that the case leader and all other team members on scene are aware. Investigators should not put themselves at risk and if they feel there is a continued threat, the team should leave the scene immediately. Where interviews are conducted on scene, the investigator must find a safe place away from moving traffic and any other risks associated with the accident scene to conduct the interview. In the interests of personal safety and legal protection, it is recommended to stay within sight of other personnel on the scene.

Personal Protective Clothing

Clothing

Investigators must always wear clothing with fluorescent areas on the upper body when working on an accident site. The clothing must conform to EN 471 class 3. All fluorescent material on the clothing should be yellow and/or orange. The top should have long sleeves. In darkness, bad weather or poor visibility, trousers with fluorescent areas must be used. The trousers should conform to EN 471 class 2. Although, it is recommended that trousers be used at all times though. High visibility clothing must be kept clean to ensure that it remains effective.

Shoes

Investigators who work on scene should wear shoes with steel toes and nail-resistant soles.

D2.3 Training Package including training manual and draft protocols

Gloves

To prevent cuts, other injuries and exposure to blood-borne pathogens, gloves must be used on vehicle inspections. Thicker protective gloves made of leather or similar must be worn on all vehicle inspections to prevent cuts and other injuries. If a vehicle is suspected to be contaminated with blood-borne pathogens (e.g. hepatitis), protective gloves made of latex must be worn under the thicker gloves to provide an additional barrier to provide protection against contamination and/or infection.

Communicable Diseases

Team members should be aware of the risk of contracting communicable diseases from direct contact with blood and other bodily fluids. As well as wearing all necessary personal protective clothing, it is also recommended that teams have an inoculation policy. Recommended inoculations include Hepatitis B and Tetanus. Occasionally road users may conceal needles or other dangerous items within their vehicle. Investigators should be very careful when examining vehicle interiors – particularly when looking for seatbelt labels at night – always use a torch when dark.

Weather Protection

In hot weather, teams working out in the open should use sunscreen and wear appropriate hats. They should be provided with lightweight high visibility clothing. Take breaks from working in direct sun where possible and keep hydrated – keep bottles of water in the DaCoTA vehicle.

For cold/wet weather teams should be provided with a good standard of high visibility weather protective garments. The team should take regular breaks in a warm vehicle if exposure is prolonged and it is recommended that a flask of hot water is carried in the car for making warm drinks.

Dealing with Distressing Accidents

Investigators may feel distressed by any of the sights, sounds or smells experienced whilst on scene or at any time afterwards and this is not always predictable. If any team member feels uncomfortable about anything they are being exposed to from attending a crash scene, then they must make their feelings known to the case leader (and the case leader should inform the team leader). Some team members may find attendance at collisions involving death and serious injury quite stressful. There should be routine de-briefing within teams. Independent counselling should be freely available, and where appropriate, staff should be instructed to attend.

Visitors/Guests

Introduction

All who participate in investigations of traffic accidents in DaCoTA must have the knowledge and equipment to be able to conduct these investigations in a safe manner. This includes third persons who accompany an investigation team to an accident site or a vehicle inspection. A third person can be either an investigator-in-training or a guest.

An investigator-in-training is someone who is accompanying a DaCoTA investigation team to an accident site or a vehicle inspection as part of his/her training. All other third persons are guests. The purpose of this routine is to provide third persons with information on how to behave in the safest possible way at an accident site or vehicle

D2.3 Training Package including training manual and draft protocols

inspection site. All third persons who accompany a DaCoTA investigation team must have read and know this routine.

Behaviour

At an accident site the case leader on site is responsible for and in charge of the investigation team. A third person who accompanies a DaCoTA investigation team to an accident must follow the case leader's instructions on where it is safe to be and what to do. If possible and applicable, the third person should accompany the case leader. A third person who is an investigator-in-training can perform some tasks such as photographing the accident site if the case leader decides he or she can do this safely, has had prior instructions in the proper routine and the task is performed as part of his/her training to become an investigator. A third person who is a guest and not in training to become a DaCoTA investigator may not perform tasks.

At a vehicle inspection site

A third person must follow the instructions of the case leader or investigator in charge of a vehicle inspection on where it is safe to be and what to do. A third person can perform some tasks such as photographing the vehicle if the case leader decides he or she can do this safely, has had prior instructions in the proper routine and the task is performed as part of his/her training to become an investigator. A third person who is a guest and not in training to become a DaCoTA investigator may do so at the discretion of the case leader or investigator in charge of a vehicle inspection.

Personal Protective Gear

The rules regarding clothing, shoes and gloves apply to third persons as well as DaCoTA investigators.

Dealing with Distressing Accidents

Visitors may feel distressed by any of the sights, sounds or smells experienced whilst on scene or at any time afterwards and this is not always predictable. If any visitor feels uncomfortable about anything they are being exposed to from attending a crash scene, then they must make their feelings known to the case leader (and the case leader should inform the team leader). The visitor should return to the DaCoTA vehicle until departure from the scene can be arranged.

Some visitors may find attendance at collisions involving death and serious injury quite stressful. They should be invited to any de-briefing within the team and made aware of the availability of counselling where required.

Car - Parking and Equipment

The vehicle used for on scene investigations is driven by one of the two members of the investigations team. A third person should not drive the car unless in an emergency. The case leader should inform a third person who has the car keys and where the first aid kit is located in the investigation vehicle.

Legal Matters

All third persons accompanying a DaCoTA investigation team to an accident site must be insured by their employer. All third persons should also be given instructions in the relevant safety procedures by a person appointed by DaCoTA. Relevant safety procedures include this routine and other routines and instructions that may be applicable.

Retrospective Investigations

When working retrospectively, teams must be aware of the same hazards as for on-scene work. In addition, special consideration should be given to the health and safety aspects of retrospective site examination.

When returning to the site of an accident, teams may wish to collect data from a live carriageway (a road with traffic), without the benefit of an emergency services presence. In many ways this can be more hazardous than data collection within on-scene investigations.

If it is necessary to enter the road on foot, then consideration should be given to what safety precautions can be taken. As always, team members must wear high visibility clothing. It is important that investigators work in pairs, with one team member measuring / taking photographs etc. while the second team member is solely responsible for alerting the other to oncoming traffic at all times.

If local permissions allow you to cone out a safe working area then do so. Also consider parking a vehicle in a fend off position if it is safe, appropriate and legal to do so. If it is unsafe to collect certain data retrospectively – then do not collect it. If the road is busy and unprotected then consider returning at a quieter time – but do not risk the safety of your team – and remember some roads may never be safe (or even legal) to enter as a pedestrian.

3. Accident Notifications

The purpose of the Accident Notifications section is to ensure that investigation teams are aware of the accidents as they are occurring. Furthermore, it is valuable to ensure that the teams are meeting their sampling criteria in a timely manner and are able to monitor and report sampling rates. It is important to ensure that the accident notification information adequately identifies all accidents that meet the sampling criteria. Also, the alarms must provide detailed information on the location of the accident.

Teams must record notifications about all accidents occurring in the sample region during the pilot study and note which accidents were accepted and rejected, and the reasons why. The accident notification data should be used to produce a brief report at the end of the pilot study. Investigation teams should also consult the Sampling Plan to determine whether the accident notifications are meeting the sampling criteria.

Accident notification should be received within 24 hours of the accident occurrence to allow the team adequate time to collect as much of the remaining information from the scene of the accident as possible. For on-scene investigations, instant notification (e.g. by e-mail, two-way radio, SMS, etc.) from the police or other emergency services when an accident occurs are required to enable the team to reach the scene of the collision before it is cleared.

Experience has shown that real-time accident notification information can lack important details. Some teams may therefore need to go on-scene to determine if accidents are to be investigated without knowing beforehand whether they fit within the Sampling Plan requirements (i.e. if the accident on a public road, road user hospitalisation status, if vehicles or road users are on-scene, etc.).

4. Photo Routine

The purpose of the Photo Routine is to detail the methodology that should be adopted to sufficiently document and record scene and road and vehicular evidence that will allow accident investigators to complete a detailed accident reconstruction and investigation. Photographic evidence should be recorded for both the scene and road as well as the accident vehicles. Therefore, the methodology detailed below is divided into Scene and Road as well as Vehicle Photos. Together, these two sections should comprise the required elements to sufficiently detail the accident scene and accident vehicles to allow investigators to conduct an investigation and reconstruction.

The methods outlined within this section should be applied in conjunction with relevant Detailed Methodology sections. Generally speaking, for all cases when recording visual evidence, it is recommended that investigators use a flash in poor lighting conditions and a tripod where practical. Generally many photos should be taken. Photos with lower quality and unnecessary duplicates can be erased afterwards.

Following steps are valid for taking photos of the accident site:

1. Overall accident site overview photos.
2. Photos of traces on and beside the road.
3. Photos of relevant measurements.
4. The approach towards the accident for each element.

Scene and Road Photos

1. Overview Photos

The overview photos should be taken in such a way to include all the major elements of the accident, including: the involved vehicles, the impact area, and the final position of the vehicles. This will hopefully provide investigators with a general description of the accident scene local road infrastructure and the environment. When overview photos are taken, reference objects like posts, traffic islands and signs together with the placing of the vehicles should be included. These photos can advantageously be taken from a height beside the road to get a good overview of the accident site. Also, ensure to get a photo in the opposite approach direction of the vehicle from a point behind the end position of the vehicle.

2. Trace Evidence Photos

As stated above, it is important for investigators to prioritize photos of evidence that may disappear soon after the accident. This includes evidence such as: glass splinters, detached vehicle parts, vehicular fluid spillage, road user biological traces, debris, etc. These items should take priority over evidence that can be recorded after the trace evidence photos. It is also noted that to have a better understanding of the size of the evidential objects, it is recommended to include a measure tape or reference object in the photo.

3. Measurement Photos

D2.3 Training Package including training manual and draft protocols

Measurement photos can be made of barriers, road markings, trace depth, support strip and ditches. These photos are of special importance if it is judged that there are defects that might have influenced the cause of the accident or the course of events. To get a better understanding of the size of the objects it could be good to include a measure tape or reference object in the photo.

4. Accident Approach Photos

The purpose of documenting the approach of the vehicle towards the accident site is to determine if the road environment contributed the causation of the accident. In rural areas, the documentation should commence at least 300m before the accident site and in urban areas at least 50m. These photos are preferably taken from inside the investigation vehicle at the height of the eyes of the accident driver. If this is not possible, the photos can be taken from the road side. A complement to the photos can be made through a video recording of the approach.

Generally many photos should be taken. Photos with lower quality and unnecessary duplicates can be erased afterwards.

The following steps should be taken when recording car and heavy vehicle photos:

1. Exterior photos
2. Interior photos
3. Detail photos of exterior and interior

As there is no interior for Powered Two Wheelers (PTW), the photo routine will differ for inspections of this type.

Car

1. Car Exterior Photos

Exterior car photos should be recorded from eight angles around the car. An overall understanding of the car exterior should be determined by following this method of recording the car exterior. This can be of service when determining the placement of detailed photos. If possible, attempt to record a photo of the roof.

In some cases, the car roof may have been removed by accident rescuers when freeing trapped occupants. Photos should be taken without the roof (in the state found), followed by photos taken in the same manner (from the eight recommended angles - as above) with the roof replaced. Investigators should ask the wrecker to replace the roof and should not attempt to replace it themselves.

2. Car Interior Photos

Interior car photos should be recorded from two angles in the front seat and one in the rear seat (where applicable) for both driver and passenger sides of the car. It is important that the opposing door is closed when taking the photo and that the front and passenger seats, area around the door opening, a part of the ceiling and the door side can be seen (as shown in the figures below). The second front seat angle attempts to record the leg space and where applicable, the pedal placement.

3. Car Detail Photos

Car detail photos should show any relevant areas of the vehicle that are helpful during the overall investigation that may not have been adequately recorded in other

D2.3 Training Package including training manual and draft protocols

exterior and interior photos. These photos can contain detail of the engine compartment as well as any relevant deformations, impacts, airbags, child restraints, safety systems, etc.

The detail photos may also record any evidence of biological traces which may reveal information regarding the mechanism of injury (e.g. blood traces on the steering wheel resulting from injury caused through contact between the road user and the steering wheel).

It is sometimes useful to include a ruler or coin within the detail photos to be able to determine the scale of the object being recorded. The car engine compartment detail photos should be recorded as they can be valuable in the overall investigation.

Recording visual evidence regarding the car seatbelts is a key component of the interior photo routine and overall vehicle inspection. The damage such as friction marks on the seatbelt can indicate that the seatbelt was in use during the accident. Furthermore, the seatbelt buckle may also reveal whether the seatbelt was worn during the accident, evident from abrasion marks left on the buckle due to the collision.

Another indication of whether the road user was wearing their seatbelt at the time of the accident is through inspection of the load limiter. The load limiter is a part of the seatbelt that is intended to limit the restraint forces applied to the occupant's thorax during a collision. The load limiter is often located at the base of the seatbelt where it coils.

Child restraint systems should be examined and detailed in the photo routine. The vehicle load may also have contributed to the accident and/or the level of injury sustained by the occupants of the accident vehicle. Photographic evidence of the vehicle load should be recorded (as shown in the figure below).

Truck

1. Truck Exterior Photos

Exterior truck photos should be recorded from eight angles around the truck. An overall understanding of the truck exterior should be determined by following this method of recording the truck exterior. This can be of service when determining the placement of detail photos. In many cases, these photos can be difficult to record as there is often limited space available. Investigators should attempt to record these photos as accurately as possible. Also, the trailer is often removed and photos of the trailer may be required to be recorded separately.

2. Truck Interior Photos

Truck interior photos should be recorded with at least two of each recorded from the driver and passenger side. It is important that the photos capture the driver or passenger seat, the area around the door opening and the foot well. The photo from an angle behind the seat (looking towards the windscreen) is preferably taken from inside the cabin and is supposed to give an overview of the driver side seat, instruments and instrument panel. Truck interior photos are also important if the protection systems of the driver will be analysed and also for the pre-crash analysis. The photos should give an overview of the driver seat, communication equipment, logistic systems, or any additional equipment used.

D2.3 Training Package including training manual and draft protocols

Photographs of the truck load should also be recorded. The type of load, arrangement, securement method and general estimate of the load weight can sometimes be determined from photos of the load. Furthermore, a loss of load should also be documented and can reveal accident causation methods. The truck load photos can be vital during the overall investigation.

3. Truck Detail Photos

Truck detail photos should show any relevant areas of the vehicle that are helpful during the overall investigation that may not have been adequately recorded in other exterior and interior photos. These photos can contain detail of the engine compartment as well as any relevant deformations, impacts, airbags, safety systems, etc.

The detail photos may also record any evidence of biological traces which may reveal information regarding the mechanism of injury (e.g. blood traces on the steering wheel resulting from injury caused through contact between the road user and the steering wheel). It is sometimes useful to include a ruler or coin within the detail photos to be able to determine the scale of the object being recorded.

In the case of the cabin displacement in relation to the chassis frame, this should be documented within the detail photos of the cabin attachment and photos from the front and side should also be recorded. Exterior detail photos of all mirrors of the vehicle should be recorded. If possible, photos of the mirrors from the driver seat angle should also be recorded.

Powered Two Wheeler

1. Powered Two Wheeler Exterior Photos

Exterior Powered Two Wheeler (PTW) photos should be recorded to give an overview of the PTW itself. An overall understanding of the PTW exterior should be determinable from these photos. This can be of service when determining the placement of detail photos.

2. Powered Two Wheeler Detail Photos

PTW detail photos should show any relevant areas of the vehicle that are helpful during the overall investigation that may not have been adequately recorded in other exterior photos. These photos can contain detail of any relevant deformations, impacts, airbags, safety systems, etc.

The detail photos may also record any evidence of biological traces which may reveal information regarding the mechanism of injury (e.g. blood traces resulting from injury). It is sometimes useful to include a ruler or coin within the detail photos to be able to determine the scale of the object being recorded. Special consideration should be given to any deformations and/or marks as they can reveal much in regards to the kinematics and overall understanding of the accident event.

The PTW tread depth is relevant to the investigation and photographs should record the level of tread on the tyres. PTW road users usually wear personal protective equipment (PPE) that differs from standard vehicle road users.

This can include: Helmet, eyeglasses, jacket, gloves, pants, shin guards and boots. All such equipment attempts to provide additional protection and visibility to the PTW road user and should be considered in the inspection.

D2.3 Training Package including training manual and draft protocols

The PTW protective equipment should be inspected for any damage and/or marks as this can reveal much in regards to the kinematics and overall understanding of the accident event. Detailed photographs of the helmet (including the fastening mechanism) and all other protective equipment should be made.

Bus

1. Bus Exterior Photos

Exterior bus photos should be recorded from eight angles around the bus. An overall understanding of the bus exterior should be determined by following this method of recording the bus exterior. This can be of service when determining the placement of detail photos. In many cases, these photos can be difficult to record as there is often limited space available. Investigators should attempt to record these photos as accurately as possible.

2. Bus Interior Photos

Interior bus photos should show the overall layout of the passenger seats, the main aisles, location of doors and driver area.

3. Bus Detail Photos

Bus detail photos should show any relevant areas of the vehicle that are helpful during the overall investigation that may not have been adequately recorded in other exterior and interior photos. These photos can contain detail of the engine compartment as well as any relevant deformations, impacts, airbags, safety systems, etc.

The detail photos may also record any evidence of biological traces which may reveal information regarding the mechanism of injury (e.g. blood traces on the steering wheel resulting from injury caused through contact between the road user and the steering wheel).

It is sometimes useful to include a ruler or coin within the detail photos to be able to determine the scale of the object being recorded. After returning to the office, all photos should be sorted and all redundant photos deleted. The remaining photos will be unidentified. The recommended method is to do so digitally, by editing the photos in a photo editing program (e.g. Adobe Photoshop, Paint Shop Pro, etc.) where selected parts can be pixelated in convenient fashion. What is important is that all identifiable elements such as faces, registration numbers and identifiable stickers are removed.

Adobe Photoshop Guidelines

Open the photo to

1. Be edited in the program.
2. Choose the "Lasso Tool" in the Standard Toolbar.
3. Mark the element to be removed.
4. Mark "Filter" -> "Mosaic" in the menu field.
5. Choose appropriate "Cell size".
6. Press "Ok".

7. Save the photo.

Paint Shop Pro Guidelines

1. Open the photo to be edited in the program.
2. Choose "Selection" in the toolbar.
3. Mark the element to be removed.
4. Mark "Flood Fill".
5. Click inside the marked area.
6. Save the photo.

Please refer to the Scene and Road Equipment List for the Photo Routine equipment list. Review the above methodology to ensure that investigators have a good understanding of it before arriving on scene.

5. Scene and Road

The purpose of the scene and road inspection is to collect information that describes the accident scene location, such as the roadway characteristics and traffic conditions. It is vital to have a thorough understanding of the accident event, the scenario leading to the accident and any causation factors in order to better conduct the overall investigation. A well conducted Scene and Road investigation can reveal much of this information.

The Scene and Road inspection attempts to collect accident scene related information which is required to subsequently fully code the accident case in the database. This information includes:

- Photographs of the accident scene, roadside, approach and accident traces (see: Photo Routine)
- Create a detailed sketch of the accident scene (see: Scene and Road Sketch)
- General road information (i.e. road type, historical and accident traffic conditions, speed limits, physical road characteristics, etc.)
- Description of Vulnerable Road User facilities (i.e. pedestrian and cycle crossings, bicycle lane, kerb height, etc.)
- Road area features (i.e. road components: barrier, lane, road side, etc.)
- Identification and description of any collision objects (i.e. animal, building, sign post, etc.)

Scene and Road inspections can be conducted on scene or retrospectively. Much of the on scene data to be collected may only be available for a finite period (due to accident site clean-up, etc.). Where possible, accident investigators should make efforts to collect any on scene data that may not remain indefinitely (i.e. pedestrian swipe marks, vehicular accident debris, etc.).

The Scene and Road methodology is divided into On Scene and Retrospective as the methodology used to conduct these two investigations differ. Despite these

D2.3 Training Package including training manual and draft protocols

differences, it is important to understand that most data required for an accident analysis can be collected on scene, depending on time constraints, obviating the requirement for a retrospective investigation. As much on scene evidence should be collected as possible.

On-Scene Investigations

The methods outlined within this section should be applied in conjunction with relevant Detailed Methodology sections. The On Scene investigation is the collection of scene and road related evidence at the accident scene location, with a focus on the collection of evidence that may only be available for a finite period. Therefore, accident investigators should make efforts to arrive on-scene as soon as possible after receiving an accident alarm.

The methodology for the On Scene investigation has been divided into the following steps:

1. Pre-Departure Preparations

After receiving an accident alarm, the investigation team should ensure they have all necessary investigation equipment (see here: Equipment List) and fulfilled all Health and Safety requirements.

2. Arrival On Scene

Once arriving on scene, the investigation team should meet the requirements of the arrival on scene, scene safety and health and safety sections to ensure a safe working environment. After meeting the above stated health and safety requirements, the investigation team should identify all those involved in the accident (i.e. all road users and accident witnesses), those involved in the rescue process (i.e. ambulance and police services) and any other relevant parties (i.e. tow truck driver). These individuals can provide the accident team with relevant information and better enable the overall scene and road investigation process.

From speaking with the relevant authorities, the investigation team should determine the length of time the vehicles will be available on scene and a description of any changes made to the vehicles in the rescue and clean-up process.

3. Scene and Road Photographs

Photographic evidence of the accident scene and road should be recorded. The detailed methodology for this process is described in the photo routine section. By following the photo routine methodology (as above), investigators should have photographic evidence that will enable the creation of a general description of the accident scene and allow for a detailed reconstruction and investigation. This includes: the accident vehicles, any temporary sight restrictions/visibility obstructions (i.e. parked vehicle(s), temporary signs, weather conditions, glare source(s), etc.), the infrastructure and environment, etc.

4. Transient Evidence

Some key scene and road evidence may only be available for a finite period and may not be available during subsequent retrospective investigations. Therefore, accident investigators should collect records of this evidence as soon as possible.

Examples of transient evidence to be collected include: vehicle positioning, traces (pedestrian traces, vehicular fluids, skid/brake marks), debris, collision objects, etc.

D2.3 Training Package including training manual and draft protocols

The majority of the transient evidence should be collected by following the above stated Photo Routine methodology.

5. Additional Evidence

All additional evidence (that which is not considered transient) can usually be collected retrospectively, therefore the detailed methodology for completing the vehicle inspection is detailed below in the retrospective section. Although, it should be noted that ideally all evidence should be collected on scene, if time allows. It is preferential for the scene and road evidence collection to be made on-scene, as much evidence is lost during the accident scene rescue, towing and cleaning processes. Depending on a variety of factors, it is possible to perform sections of the investigation retrospectively. Although it should be noted that the majority of evidence collected can and should be collected during the on-scene scene and road investigation, where possible. Therefore, the following methodology can be followed during an on-scene investigation if time allows.

Retrospective Investigations

Any retrospective accident scene site inspection should be conducted as soon as possible to retain as much evidence as possible, as much of the transient evidence may no longer be available over an elapsed time.

During a retrospective investigation, it is important to remain open-minded, even if the investigation team already has been provided a sequence of events (e.g. do not be limited by the police search as the retrospective investigation can reveal missed information).

1. Pre-Departure Preparations

Before departing for the retrospective scene and road accident site visit, the investigation team should ensure they have all necessary investigation equipment and fulfilled all Health and Safety requirements. To enable an efficient retrospective investigation, it is important to collect as much relevant information as possible on the sequence of events before attending the accident scene site inspection as this may focus the investigation area and facilitate an overall better understanding of the accident event before arriving on scene.

It is also important to procure detailed information on the position of the accident. If the scene has been cleaned and the vehicle(s) towed, with little remaining evidence of an accident, it may be difficult to determine where to take road measurements if no exact position is given. The following points are important to consider whenever undertaking a retrospective investigation:

- Communicate details of the planned inspection with police and road authorities in advance;
- Prepare the route to the crash scene in advance;
- Collect data about the crash scene and the direct environment: police data, maps, Google Earth and Streetview, internet and news sites. Take this data to the crash scene;
- Develop potential accident scenarios and determine the information required to evaluate these scenarios;

D2.3 Training Package including training manual and draft protocols

- Forecast potential issues beforehand and attempt to mitigate appropriately (e.g. doubts about the driving directions of the vehicles, the exact crash location, etc.).
- Based on the available information, determine the safety work zone at the crash scene.

To determine relevant accident information, use sources such as online media websites that publish news items within hours (or less) of the initial accident occurrence. The text of these articles often contain detailed information about the accident (e.g. driving direction, driver(s) and passengers (including statements of the driver(s) and/or witnesses), injuries, car damage, objects struck, etc.). The articles often have pictures with information about car (brand and type), damage, end position, objects struck, emergency services at the site, etc.

Furthermore, it is possible to use information from (local) police, emergency services, and scrapyards. This information is usually available within some days (or less) after the initial accident occurrence. Additionally, Google Earth/Maps or other up to date maps can be used to get information about the approach route, surrounding land use, curvature, speed limits, etc. Google Streetview or other up to date pictures can be used to get detailed information about the carriageway and roadside (note: always confirm this information during the site visit), surrounding land use, sightlines (stop and sight distances), street furniture, etc.

Use Google Streetview or other up-to-date and digital pictures to get information about the available space for creating a work zone in which the crash site could be inspected in a safe way and according to the local guidelines or legislation. Contact the police or road authorities in advance, to notify them of the upcoming inspection.

2. Retrospective Accident Scene Arrival

Once arriving on scene, the investigation team should meet the requirements of the Arrival on Scene and Scene Safety Health and Safety section to ensure a safe working environment. After meeting the above stated health and safety requirements, the investigation team can begin the retrospective investigation evidence collection process.

3. Retrospective Scene and Road Visual Evidence

The majority of evidence collected will be in the form of photographic records. Any evidence that was not collected during the on-scene (if any) investigation should be collected during the retrospective accident scene site visit.

Photographic evidence of the accident scene and road should be recorded. The detailed methodology for this process is described in the photo routine section. By following the photo routine methodology (as above), investigators should have photographic evidence that will enable the creation of a general description of the accident scene. This includes: the roadway and approach, the infrastructure and environment, etc.

Furthermore, creating a video record of the last 1000 (or minimum 500 metres) of the vehicle route(s) should be made. This video evidence should give investigators the road user perspective shortly before the accident and the expectations during the approach to the crash site. To this end, the following characteristics should be recorded:

1. Vertical and horizontal alignment;

D2.3 Training Package including training manual and draft protocols

2. Consistency of the presence of curves and bends shields;
3. Pavement type and quality of pavements;
4. Type and condition of axis marking;
5. Type of direction separation and / or median;
6. Type and position of any parallel (moped and/or) bicycle facilities;
7. Presence of sorting strips, parallel roads, slip lanes, hard shoulders and parking facilities;
8. Any changes from a previous road section;
9. Presence of pedestrian crossing facility;
10. Presence and consistency of traffic inhibitors (speed humps, speed tables);
11. Presence of light towers, reflector posts and hectometre poles;
12. Description of the environment and the presence of trees and shrubs;
13. Traffic signs along the route (including text-boards and any possible problems with the performance or visibility).

4. Cross Section Measurements

In performing cross section measurements, it is important that one investigator measures the cross section and take pictures, while the other investigator keeps an eye on the traffic.

Cross-sectional measurements should be taken (at minimum) at:

1. Vehicle conflict point
2. Any location where the vehicle(s) had a run of road
3. Final resting points of the vehicle(s)

A laser distance meter with tilt sensor (digital inclinometer) can be used to measure road characteristics on the road surface or in the roadside from out of a work zone in the verge at a safe distance of moving traffic. If the inspection vehicle can be parked in the shoulder of the roadway or on a cycle lane, measurements can be carried out without having to block a traffic lane. The laser meter with tilt sensor can also be used to measure angles of cross fall (slope of road surface), slopes of embankments or cuts, etc.

- The following road characteristics of the cross section should be collected:
- Road category (residential road (Zone30), rural access road (Zone60), distribution road (80 km/h) or flow road (A-level road), motorway 100/120 km/h));
- Lane configuration (e.g., 2x1 or 2x2);
- Speed limit on site;
- Road situation on the spot (intersection / road section; straight / bend);
- Radius if the crash occurred in or behind a curve;

D2.3 Training Package including training manual and draft protocols

- Width of the pavement, edging and lanes of driving strip;
- Width and type of axis marking, separation of driving directions and other marking and lines;
- Type and width of hard shoulder, semi-hardening, widths of obstacle-free zone, safety-/ breakdown zone, and roadside vegetation free zone, type of (rigid) obstacles, connection with the pavement;
- Type of cut or embankment, slope (degrees) and width to crown and toe line,
- Type and width of any devices in parallel and the width and material of the intermediate berms.

If a safe site inspection is not possible with the available safety equipment, for example on a 100km/h-road, only filming the road will be possible and additional measurements have to be carried out using estimations based on Google Earth and Streetview. The radii of curves can also be determined using Google Earth.

5. Back at the Office

After returning to the office, it is important to properly compile the evidence collected during the investigation. This can be facilitated through:

- Inserting a minimum set of variables into the database without delay enabling other team members to continue working on the case
- Creating a scale plan using appropriate software (see: Scene and Road Sketch)
- Checking the quality of the data and entering the full data into the database
- Removing any vehicle identifiers (i.e. license plate numbers, etc.) and sorting/uploading the photos

a. Scene Measurements

The purpose of making scene measurements is to establish a better understanding of the positioning of relevant accident elements and to enable an accurate sketch to be created. The scene measurements provide valuable data to accident investigators that give a better overall understanding of the accident and aid in the reconstruction process.

There are numerous methods available to accident investigators for making scene measurements. Each method system has unique advantages and disadvantages that the investigators should consider when applying a particular measurement system. There are several alternate measurement techniques available using highly sophisticated equipment such as laser scanners, total stations, theodolites and differential GPS. These systems require an experienced user but can save time while collecting high quality data. However, due to the cost they are unlikely to be used for most accident scene investigations and therefore further details will not be described.

Orthogonal Coordinate Grid System

A simple method of measuring the accident scene is to record the measurements on an orthogonal coordinate grid by first finding a reference point and then defining a (straight) reference line which will represent the X-axis. The Y-axis measurements are then measured perpendicularly to the reference line.

D2.3 Training Package including training manual and draft protocols

Premises

- One or two persons available
- Straight and simple road layout is present

Steps

1. Establish Reference Point

Measurements of the accident scene can be facilitated by first establishing a fixed reference point. The point of reference must be fixed and can be street lamps, fixed posts, building wall corners, etc.

2. Define Reference Line (X-axis)

After selecting an initial reference point, an axis can be established from the reference point. This axis will form the reference base that all other points of interest will be measured against.

3. Accident Site Elements

After establishing the X-axis, all additional points of interest can be given as measured distances in the Y direction from the defined X-axis (note: for long distances (>3m), it is recommended to use a measurement wheel and for short distances (<=3m), a measurement tape (2 persons) can be used).

Pros

- Relatively fast and simple measurement method

Cons

- Requires a simple road layout

Triangulation

With this procedure, two points of reference are selected, where the distance between these points is known. The distance to each point of interest should then be measured from both the two reference points.

The angle between the reference base line and the line to the point of interest should not be obtuse nor too acute. If the distance between reference point A and point B is too long and interest point C is too close to the connecting line AB, then there won't be an intersection and point C cannot be found with this method.

An acute angle and inaccurate measurement causes an offset of point C.

Premises

- Two persons available
- Complex measurement on straight road layout

Steps

1. Establish Reference Points

DaCoTA_D2_3_training materials_Final.doc

D2.3 Training Package including training manual and draft protocols

Measurements of the accident scene can be facilitated by first establishing fixed reference points. These points of reference must be fixed and can be street lamps, fixed posts, building wall corners, etc. At least two points of reference are required to make accurate measurements. These two reference points will act as base points to which all additional points of interest are related to.

2. Determine Distance between Reference Points

After defining the reference points, the distance between the two should be measured.

3. Accident Site Elements

After establishing the reference points and determining the separating distance, the location of various evidential elements of interest can be determined. All relevant accident elements (i.e. accident vehicles, collision objects, transient evidence, traces, debris, etc.) should be measured in relation to the original reference points. The angles between the reference points and the point of interest are used to determine the position of the point of interest in relation to the reference points. Each point of interest should also be numbered to enable accurate record keeping and identification of each element.

Pros

- Very accurate method for measuring as long as the point of interest is within a suitable area

Cons

- Takes more time than other methods
- Two persons required for measuring
- Low level of accuracy for obtuse and acute angles
- Triangulation with Moving Reference Points

Triangulation with Moving Reference Points

If the accident site is relatively large or complex, it can be divided into a network of triangles. These triangles can be measured according to the same principles as stated in the above triangulation method. The measured points are then used as reference points to measure the next unknown point until all unknowns have been accounted for.

Premises

- Two persons available
- Complex road layout is present with a relatively large area.

Steps

- Same as above triangulation, but with multiple triangles.

D2.3 Training Package including training manual and draft protocols

Pros

- Very accurate measurement method

Cons

- Time consuming
- Two persons required for measurements

Path Coordinate System

A path coordinate system is a measurement method where the x-axis is set to follow a path (e.g. the road edge) and the y-axis values are measured perpendicular to the x-axis. This, however, requires that the path itself is well defined.

Premises

- One or two persons available
- Path can easily described

Steps

1. Establish Reference Point

Measurements of the accident scene can be facilitated by first establishing a fixed reference point. The point of reference must be fixed and can be street lamps, fixed posts, building wall corners, etc.

2. Define Reference Line (X-axis)

After selecting an initial reference point, an axis can be established from the reference point. This axis will form the reference base that all other points of interest will be measured against. As stated above, the X-axis is usually chosen to follow the road path.

3. Accident Site Elements

After establishing the X-axis, all additional points of interest can be given as the perpendicularly measured distances in the Y direction from the defined X-axis (note: for long distances (>3m), it is recommended to use a measurement wheel and for short distances (<=3m), a measurement tape (2 persons) can be used).

Pros

- Very simple method for measuring of complex road path

Cons

- Long chords required for accurate measurements
- Perpendicular measurements may be difficult

Photogrammetry

Photogrammetry is the practise of producing real world measurements from photographs. There are several photogrammetric techniques available. 2-D photogrammetry methods require only one photograph and can provide adequate accuracy for nominally flat surfaces. Even when no measurements have been taken

D2.3 Training Package including training manual and draft protocols

at the time of an accident, it is possible to obtain adequate dimensional data to rectify photographs by going to the scene and taking measurements of painted lines or other long-lasting roadway features that appear in the original photographs.

Premises

- One or two persons available
- Measurement of the reference distances only

Steps

1. Define reference points

Measurements of the accident scene can be facilitated by first establishing fixed reference points. These points of reference must be fixed and can be street lamps, fixed posts, building wall corners, etc. At least two points of reference are required to make accurate measurements. These two reference points will act as base points to which all additional points of interest are related to.

2. Determine Distance between Reference Points

After defining the reference points, the distance between the two should be measured.

3. Accident Site Elements

Based on the scale of the photograph and the known distance between the reference points, the remaining accident site element points can be established by measuring the distances on the photograph itself and scaling the result.

Pros

- Very simple method for measuring of complex road path
- No on-site measurements beyond the reference distances

Cons

- Measurement points must be clearly visible

b. Scene and Road Sketch

The purpose of completing a scene and road sketch is to show all the relevant elements necessary for an accident reconstruction in one place. The sketch should include all relevant elements to enable a detailed accident reconstruction. The sketch should be based on photos and measurements of the scene itself. It is recommended to take initial pictures of the accident scene, before creating chalk measurement markings. A second set of pictures can then be taken after the markings have been made. The markings should include a numbering of the evidence so that accurate correlations can be made between the pictures and the measurements.

A detailed scene and road sketch should include the following:

- The road and its surroundings, including infrastructure type (e.g. intersection, straight section, etc.)

D2.3 Training Package including training manual and draft protocols

- Relevant measurements (e.g. road width, shoulder width, distances to roadside furniture, etc.)
- Road pavement markings (double line, turning arrows, etc.)
- Point of collision and final accident vehicle positioning
- Highlighted areas where accident evidence traces were found
- Accident vehicle brake and skid marks
- Road furniture both fixed and mobile (traffic lights, signs, barriers, etc.)
- The initial driving direction of the accident vehicles
- Accident vehicle path(s)
- Position of collision objects before and after impact
- Pictures may also be included directly within the sketch

The methodology for creating a scene and road sketch is divided into the following three steps:

1. Perform the accident scene measurements.
2. Create the initial draft sketch.
3. Digitalise the initial sketch to a digital scaled sketch.

1. Accident Scene Measurements

The Accident Scene Measurements methodology is detailed in the Scene Measurements section.

2. Initial Sketch

By following the Scene Measurements methodology, accident investigators should be able to create an initial hand drawn sketch of the accident scene, including all relevant points of interest.

3. Digital Scaled Sketch

As the initial sketch may be difficult for others to understand, it is important digitalise the initial draft. Furthermore, a digital sketch can also be properly scaled. The final scaled sketch can better enable the accident reconstruction process.

There are a number of different software packages available to facilitate the creation of a digital scaled sketch (i.e. Adobe Illustrator, PC Crash, PC Rect, etc.). A suitable software program should be selected to allow for a clear and accurate plan to be made.

6. Vehicle Inspection

The purpose of the vehicle inspection is to collect data that describes the vehicles involved in an accident, including general vehicle information, its condition, damage, safety equipment and occupant information, to a level that will enable a detailed case analysis and accident reconstruction. The vehicle inspection also includes the collection of data relevant to any child occupants such as the use of child restraint

D2.3 Training Package including training manual and draft protocols

systems. The vehicle inspection attempts to collect vehicle related information which is needed to subsequently fully code the accident case in the database.

This information includes:

- Photographs of the vehicle exterior, interior and accident traces (see: Photo Routine)
- General information about the vehicle (e.g. make, model, engine, gearbox type, cargo, etc.)
- Deformations of the vehicle due to the accident (e.g. CDC, deformation measurements, etc.)
- Exterior observations (e.g. functionality of doors, deformation of door hatches, damage to windows, etc.)
- Interior observations (e.g. intrusions, information on airbags and seat belts, seat positions, marks from passengers due to a collision)
- Vehicular Event Data Recorder information (if applicable)
- Identification of vehicular safety systems from inside and outside the vehicle (e.g. ABS, electronic stability program, lane departure warning, Alcolock system, cruise control, etc.)

Vehicle inspections can be conducted on scene or retrospectively. Much of the on scene data to be collected may only be available for a finite period (due to accident vehicle towing, etc.).

Where possible, accident investigators should make efforts to collect any on scene data that cannot be collected retrospectively. The vehicle inspection methodology is divided into on-scene and retrospective as the methodology used to conduct these two investigations differ. Despite these differences, it is important to understand that most data required for an accident analysis can be collected on scene, depending on time constraints, obviating the requirement for a retrospective investigation. The methods outlined within this section should be applied in conjunction with relevant Detailed Methodology sections.

On Scene

The on-scene investigation is the collection of accident vehicle related evidence at the accident scene location, with a focus on the collection of evidence that is only available for a finite period.

The methodology for the on-scene investigation has been divided into the following steps:

1. Pre-Departure Preparations

After receiving an accident alarm, the investigation team should ensure they have all necessary investigation equipment (see here: Equipment List) and fulfilled all Health and Safety requirements.

2. Arrival on Scene

D2.3 Training Package including training manual and draft protocols

Once arriving on scene, the investigation team should meet the requirements of the arrival on scene and scene safety health and safety section to ensure a safe working environment.

After meeting the above stated health and safety requirements, the investigation team should identify all those involved in the accident (i.e. all road users and accident witnesses), those involved in the rescue process (i.e. ambulance and police services) and any other relevant parties (i.e. tow truck driver). These individuals can provide the accident team with relevant information and better enable the overall accident investigation process. Furthermore, it is usually necessary to receive permission from the accident vehicle owner (and in some cases, the police) to access the interior of their vehicle.

From speaking with the relevant authorities, the investigation team should determine if and where the accident vehicle(s) will be available for a retrospective investigation, an estimate of the length of time the vehicles will be available on scene and a description of any changes made to the vehicles in the rescue and clean-up process.

3. Vehicular Photographs

Photographic evidence of the accident vehicle(s) should be recorded. The detailed methodology for this process is described in the photo routine section.

4. Transient Evidence

Some key vehicular evidence may only be available for a finite period and may not be available during subsequent retrospective investigations. Therefore, accident investigators should collect this data as soon as possible. Transient evidence includes: pedestrian swipes, biological traces, vehicular fluid traces, debris, interior cargo and broken glass found within and on the vehicle.

5. Additional Evidence

All additional evidence (that which is not considered transient) can usually be collected retrospectively, therefore the detailed methodology for completing the vehicle inspection is detailed in the Retrospective section. Although, it should be noted that ideally all evidence should be collected on scene, if time allows.

Retrospective

The retrospective investigation is the collection of accident vehicle related evidence at the accident vehicle storage location (e.g. scrap yard, garage, home of the owner, etc), with a focus on evidence that was not collected during the on scene investigation. The vehicle investigation should preferably be completed on scene as transient evidence may still be visible, however, due to the time consuming nature of the inspection itself and the sometimes limited available time frame at the accident scene, it may be necessary to complete the vehicle inspection retrospectively. In this case, the inspection should be completed as soon as possible at the accident vehicle storage location.

The methodology for the retrospective investigation has been divided into the following steps:

1. Pre-Departure Preparations

D2.3 Training Package including training manual and draft protocols

After determining the accident vehicle storage location, the investigation team should ensure they have all necessary investigation equipment and fulfilled all health and safety requirements. If not already done so, the investigation team should procure permission to enter the accident vehicle from the owner and any other relevant authority.

2. Arrival at Accident Vehicle Storage Location

Once arriving at the accident vehicle storage location, the investigation team should identify the vehicle to be inspected. This may seem trivial, but depending on the extent of damage and number of similar vehicles at the storage location, care should be taken to ensure the correct vehicle is inspected. This can be facilitated through comparison of the VIN number plate and/or chassis number on the vehicle to the vehicle registration.

After the accident vehicle to be inspected has been identified, it may be necessary for the investigation team to receive assistance (from the wrecker or tow truck operator) to move the vehicle to a place that will allow adequate area around the vehicle to facilitate the inspection. For safety reasons, the investigators should also ensure that the vehicles battery is unplugged and any airbag systems are deactivated.

3. Vehicular Photographs

If not collected during the on scene investigation, photographic evidence of the accident vehicle(s) should be recorded. The detailed methodology for this process is described in the photo routine section.

4. General Vehicle Information

General information about the accident vehicle should be collected by the investigation team during the vehicle inspection. This includes information regarding the vehicles:

- Make / Model
- Fuel and Powertrain
- Geometry and Weight
- Cargo
- Modifications

The majority of this information should be determinable from the vehicles registration certificate, visual inspection of the vehicle and through interview with the vehicle owner.

5. Deformations

Vehicular deformations resulting from the accident are measured and recorded by the investigation team during the vehicle inspection in order to determine the extent of damages and to categorize the deformations. A systematic approach is applied to record the deformations, which should allow investigators a more accurate correlation between impacts and road user injuries in their analysis.

6. Exterior Observations

D2.3 Training Package including training manual and draft protocols

Exterior observations should be recorded by the investigation team during the vehicle inspection. These observations include:

- Evidence of fire damage
- Fuel system and battery damage
- Observed fluid leakage
- Condition of doors, windows and glazing
- Description and condition of wheels and tyres
- Trailer information (if applicable)

The majority of this information should be determinable from visual inspection of the vehicle and through interview with the vehicle owner.

7. Interior Observations

Interior observations should be recorded by the investigation team during the vehicle inspection. These observations include:

- Condition of interior vehicular components (e.g. steering wheel, dash panel, footwell, etc.)
- Belt and seat description
- Airbag system description
- General interior observations (e.g. impact marks)

The majority of this information should be determinable from visual inspection of the vehicle, vehicle manufacturer information and through interview with the vehicle owner.

8. Event Data Recorder

Vehicles equipped with Event Data Recorders may offer investigators additional information about the accident that may aid in the overall analysis.

9. Safety Systems

A description of the accident vehicles safety system should be recorded by the investigation team during the vehicle inspection. Aspects of the system that should be noted include:

- Support and warning systems (e.g. cruise control, lane departure warning, GPS, etc.)
- Brake and handling system description
- Visibility system (e.g. xenon lights, night vision, etc.)

The majority of this information should be determinable from visual inspection of the vehicle, vehicle manufacturer information and through interview with the vehicle owner.

Powered Two Wheelers

D2.3 Training Package including training manual and draft protocols

Special consideration is required when investigating accidents involving Powered Two Wheelers (PTW) as there are differences between a PTW and a standard vehicle (i.e. car) inspection. For this reason, this section is devoted specifically to the particularities of PTW inspections.

A PTW inspection should be carried out in the same format and methodology as described above for a standard vehicle inspection with the following particularities:

Photo Routine

The photo routine will differ from the standard vehicle inspection in that there will be no interior photos in the case of PTW investigation. Peculiarities of the PTW photo routine can be found in the Powered Two Wheeler section of the Photo Routine.

Deformations

Special consideration should be given to any deformations and/or marks as they can reveal much in regards to the kinematics and overall understanding of the accident event.

Braking System

PTW braking systems differ significantly from car systems and require special consideration. Some PTW are equipped with ABS brakes and should be verified by the owner or by consulting manufacturer specifications. Visual inspection of the brakes (both front and rear) should be performed, followed by capturing relevant photographic evidence.

Inspection of the brake controls should also be made. Most PTW have separate left and right handlebar brake controls, controlling the front and rear brakes. In some PTW's, the rear brake is controlled by the right foot.

Tyre Thread Depth

PTW tyres require significant thread depth and curvature to maximise road area contact while leaning through a curve. The depth of the tread should be well noted during the inspection.

Trucks

Special consideration is required when investigating accidents involving trucks (Heavy Vehicles) as there are differences between a truck and a standard vehicle (i.e. car) inspection. For this reason, this section is devoted specifically to the particularities of truck inspections. A truck inspection should be carried out in the same format and methodology as described above for a standard vehicle inspection with the following particularities:

Truck Type

There are various types of truck trailers and body types in use. It is useful for the investigator to determine the type in use.

Load Type

Trucks that contain loads that may be considered hazardous (e.g. flammable, explosive, etc.) should display their load type on the exterior of the vehicle. Signs displaying the hazardous material type should state the type of hazard that the truck

D2.3 Training Package including training manual and draft protocols

contains. The hazardous material type should be recorded for each truck investigated. Sample load hazard types are shown in the figure below.

Vehicle Specifications

Certain truck specifications are usually stated on a plate on the side of the vehicle. This plate can contain information regarding the empty weight, length, width and surface area of the vehicle. This evidence is useful to the investigator and should be recorded. Furthermore, if the load is still present, it may be determinable if the vehicle was overloaded in the accident.

Tachograph System

Some trucks are equipped with a tachograph system. A tachograph system states the number of working and resting hours for the truck. Tachograph systems are predominantly either digital or analogic. In the case of an analogic system, a photograph of the display reading should suffice as an adequate record. In the case of a digital system, card access may be required.

Bus

Special consideration is required when investigating accidents involving buses as there are differences between a bus and a standard vehicle (i.e. car) inspection. For this reason, this section is devoted specifically to the particularities of bus inspections. A bus inspection should be carried out in the same format and methodology as described above for a standard vehicle inspection with the following particularities:

Bus Type

There are various types of buses in use and the type of bus involved in the accident should be determined and recorded.

Occupant Allowance

Buses are somewhat unique to other vehicle types in that they allow for standing occupants. In addition to the number of seat placements within the bus, the number of permitted standing occupants should be determined and recorded.

7. Vulnerable Road User

The purpose of the Vulnerable Road User section is to collect data that describes all vulnerable road users (VRU) (pedestrians, motorcyclists, pedal-cyclists) involved in the accident, including their role in the accident causation, sources of injury, whether they were equipped with protective clothing, a record of any contact marks and other related scene evidence.

All Teams

- General vehicle examination for motorcycles (powered two wheelers) and pedal-cycles.
- Identification of vehicle safety features (ABS, Traction Control, Adaptive lights).
- Examine if tyres or rims (and other vehicle parts) were damaged due to the accident,
- Checking for scrape marks and cracks.

D2.3 Training Package including training manual and draft protocols

- Check if the upper protective system integrates an airbag or neck protection

Experienced Teams

- Examination of the PTW for motor power enhancement
- Inspect the fuel management system for enhancement
- Evaluation of the effectiveness of systems such as brakes and suspension.

All Teams

- In addition to scene/road examinations (item 5), examine and record approach paths for PTWs, pedestrians and bicyclists, and take measurement, such as throw distances and skid marks at scene.
- Look for evidence of locked wheels on tyres
- Exterior contact marks from VRU's on opponent vehicle.
- Look for helmet damage caused in the accident.
- Examination of helmets, body armour and protective clothing.
- Examine if helmets and visors were certified for PTW use.
- Developing teams and experienced teams
- In addition to injury coding described in medical data, identify the body regions that contacted the other vehicle or object on the road.

Experienced Teams

- Examine the protective equipment (helmets and clothing) to assess impact performance
- Examine if the personal protective equipment was fitted correctly and worn in the correct place

All Teams

- At least one team member trained in collecting VRU specific variables

Experienced Teams

- PTW specialist on team

8. Behavioural Data

The purpose of behavioural data is to collect data (mainly from interviews /questionnaires) to understand and describes road user behaviour and relevant background information in support of the overall accident analysis.

Interviews are the main method for collecting road user behavioural data but all data collection can give information valuable for evaluating road user behaviour. Interview material should be stored locally and as complete as possible for later re-analysis by

D2.3 Training Package including training manual and draft protocols

the team, if local laws and guidelines allow. Database entries to be made fully anonymous, without any personal names, addresses or vehicle registration numbers included.

On Scene

- On-scene contact and if possible ask questions concerning the course of events and possible causes of the accident.
- Full interview according to a semi structured form to be conducted as soon as possible, on-scene, at hospital, or retrospectively by phone/face to face.

On Scene and Retrospective

- Interviews should be conducted as soon as possible after the accident and if possible face to face.

As it is not always possible to conduct an interview on-scene, the methods recommended here are to be tried in following order

1. On-scene interview
2. Interview at hospital
3. Retrospective interview face to face or by phone
4. Postal questionnaire

All Teams Arrangements

- Check national legislation and guidelines for possibility to process potentially sensitive personal findings as anonymised data.
- Ethical approval if necessary.
- Consent forms to perform interview if needed.
- Investigators trained in conducting interviews.

a. Interview Guidelines

The act of interviewing road users regarding a road traffic accident is an involved task due to the emotional significance, legal context and the practical conditions. There is therefore a requirement to adapt the interview method accordingly. The purpose of the interview guidelines section is to describe the difficulties likely to be encountered in the application of the semi-directive interview method as well as some of the techniques which are advisable to implement to mitigate these difficulties.

In-depth accident studies rely upon a detailed approach designed at gaining as much information about the event as possible (clinical type approach). The collection of data is inevitably interdisciplinary and thus a number of investigators are active concurrently. These investigators are specialist in (among others) the dynamics of vehicles, kinematics, mechanics, biomechanics, infrastructure and psychology.

D2.3 Training Package including training manual and draft protocols

The consideration of the "human factor" (road users) in its interaction with the other components of the vehicle-human-environment system implies a psychological dimension. The ideal is to rely on the expertise of specialists in the study of human operator behaviour when engaged in the driving task (ergonomics, cognitive psychology) for the collection of human data and the analysis of their influence in the accident mechanisms. In any case, the interviewer having an understanding of the human processes at play in driving and in accidents is highly desirable.

The following sections summarise the difficulties likely to be met in the course of the interview in the particular context of the accident, and provides some techniques which can be implemented to mitigate these difficulties: which attitude to adopt with the interviewees, how to establish a good interview relationship, how to engage the person in the interview, which questioning techniques to use, which adaptive procedures are effective, how to manage interventions from other people (in the case where others are present e.g. at the accident scene).

The Interview Guideline Methodology also attempts to detail how to utilise information gained through exchanges with the investigator and the importance of relating with the people involved (i.e. rescue services, police, etc.).

1. Timing

In regards to the determining when to conduct the interview, the ideal situation would be to conduct the interview as soon as possible, in consideration of the availability of the people involved. This is done so that the interviewee delivers the most spontaneous information, before mental reconstruction or mediation takes place as a result of discussion with others.

An efficient way of proceeding relies upon a data collection procedure divided into two stages:

- An initial interview: a relatively brief (considering the circumstances) on-scene interview at the accident scene (or in the emergency rooms of the hospital).
- A follow-up interview: a complementary data collection interview within 48 hours of the accident. The investigators should direct their questions based on their initial understanding of the accident, resulting from the initial interview and an examination of the first data collected by the interdisciplinary team.

2. Preparation

The collection of immediate recollections improves the chances of receiving genuine and more accurate statements from interviewees, without interference resulting from the interviewee talking with others about the accident or mental reconstruction self-reflection regarding the events. In the absence of these conditions, it is necessary to be aware of the biases which can affect the testimony.

The interviewer has to approach the interviewees without any preconceptions to avoid the risk of biasing the interview by questioning directed subjectively. But not having preconceptions does not mean being ignorant of any available information. It is necessary to prepare for the interview by becoming familiar with the material circumstances of the accident.

It is useful to know beforehand: the number of vehicles involved, the overall configuration of the crash, available evidence, etc. In this respect, to have observed

D2.3 Training Package including training manual and draft protocols

beforehand the site of the accident constitutes a main requirement for an effective interview and an understanding of the facts described by the road users.

This preparation can develop from dialogue with other investigators involved in the case analysis. This preliminary information does not have to result in conclusions, but to assist investigators in determining appropriate questions to ask.

More generally speaking, investigators must have an understanding of the different topics they are required to cover during the interview. The use of an interview guide is useful during the interview to verify the points which have not been developed yet. But this guide should not be followed too rigidly: a good interview occurs when the different questions come about naturally, as would happen in normal conversation.

Indeed, the reactions of the interviewee in these particular conditions can be very diverse and the interviewers should account for these differences and adapt accordingly, in respect for those involved, the ethical rules, and in the objective to collect the best information necessary for the understanding of the accident. The technique of the "semi-directive" interview must, according to the particular situation, be revised either:

- "Downward": to reduce the rigidity of the interview and allow the interviewee to express themselves freely on a subject which affects them, even if it does not interest directly the analysis of the accident (e.g. when the person is manifesting a very strong emotion)
- "Upward": encouraging the interviewee to clarify any discrepancies or suspected misappropriated statements to ensure their claims are reliable and accurate, even if it means pushing the person in a more directive way (e.g. when this person is obviously insincere or resistant).

3. Interview Commencement

To achieve an efficient interview, the investigator needs not only the agreement of the interviewee, but even more so the investigator needs to install a sense of support in the interviewee for the project and its aim to investigate all the facts of the accident. The interviewer should emphasize the importance of the results of the overall project in improving road safety. The quality of the introduction influences the quality of the following of the interview, so it is advisable to take the necessary time to do the following:

- Introduce oneself by name and role, do not hesitate to give your name
- Briefly introduce the DaCoTA project and its purpose
- Present the frame and the purpose of the work. Keep explanations concise and factually based (i.e. "We analyse vehicular accidents to understand how and why they happen, to hopefully determine how to reduce the number and severity of future accidents. Your witness account of the accident event is vital to our research").
- Reassure the interviewee by stating the ethical guarantees of discretion and non-disclosure of the contents of the interview (independence with regard to investigations of police or justice, anonymity in the use of the results).
- If necessary, involve the interviewee in this work, by assigning them the role of an irreplaceable witness (i.e. "How did this accident occur? I need you to explain it to

D2.3 Training Package including training manual and draft protocols

me what happened to understand the events that led to the accident. Your witness account is one of the most vital components to our understanding of the accident.". Remind him/her that this study can allow the prevention of other accidents.

- Outline the protocol for the interview. "I would like to begin by listening to your account of the accident in as much detail as possible.". Then proceed with the interview: "Is that OK? Do you understand? We will start now... ".

4. Questioning

The investigation should cover the follow topics:

- The preliminary driving situation, momentarily prior to the accident event (speed of approach, intentions, expectations).
- The nature and the conditions of the problem encountered (manoeuvres made by themselves and of others).
- The emergency situation (protective manoeuvres).
- The collision event itself.

For each of these phases, the interviewer must gather information on the nature of the perceived elements, the interpretations, the decisions and the operations made. In order of importance, the first key question is

"How?", the second is "Why?" (i.e. "What did you do?", and "Why that way?").

As a general rule, a novice investigator may be satisfied with general answers, and believes to have understood everything at the very moment when numerous details or answers remain ambiguous or unanswered (i.e. a person who says " I did not see him arriving" can really mean, "I did not see that he arrived so fast").

We recommend three distinct phases in the interview: a first phase (Open Phase) of listening centred on the progress of the accident, a second phase (Deepening Phase) of gaining a deeper understanding and questioning on this progress and a third phase (Filling-in Phase) centred on the contents of the information check list.

1. Open Phase

It is better to begin with the progress of the accident as it may be what the interviewee expects. In the first stage, the principle is to let the interviewee speak as freely possible, for as long as they chose to speak (as long as they remain on subject).

The open phase is initialized by an open question, such as "Can you tell me how that took place?". The purpose of the open phase is to collect an overall view of the accident, while retaining as much detail as possible.

It is the interviewee who knows what took place and it the task of the investigator to listen to them. If the interview begins with closed questions, the interviewer risks disengaging the interviewee, putting him in a situation of unpleasant interrogation,

D2.3 Training Package including training manual and draft protocols

into a passive position of waiting for the following question, thereby running the risk of discouraging the information source.

Also, the investigator will avoid premature interruptions as the risk is too great of preventing the interviewee from delivering relevant information that may not have been revealed otherwise. In this stage, it is recommended to allow freedom of expression on behalf of the interviewee. This allows the interviewee to become comfortable with the interviewer and to feel confident in giving their response.

2. Deepening Phase

The second stage consists of an exploration of the information gathered during the open phase, hopefully leading to a deeper understanding of the accident. The deepening phase should concentrate on specific details, to investigate the "blanks", the ambiguities and the contradictions. This stage is more directive, the questioning is therefore more methodical. The investigator uses what he knows already to gain further knowledge. Once again, a good knowledge of the accident facts will help at this stage.

3. Filling-in Phase

The final stage, the filling-in phase constitutes a change in the content of the interview which may reveal new information. It is good to make a transition. It is suggested that this transition is introduced, i.e., "I would now like to ask questions which concern you more personally, as we try to understand if there are other background factors that alter the risk of having an accident. For example, I would like you to tell me about your experience of driving, how long have you driven, on which roads, your annual mileage...", etc.

With such an introduction, the interviewee finds it normal to answer questions of this nature. It is recommended that the investigator continues to conduct the interview in the manner of conversation which it had until then. The use of a check list as a questionnaire at this stage may detract from the interview by asking questions mechanically, one after the other. As mentioned earlier, the check list is only a list of themes to be investigated. It is best for the investigator to have them in mind and possibly consult it as a reminder, to verify that nothing was forgotten.

Throughout the interview, it is important to be reminded that the information collected will eventually be coded into the DaCoTA database: the investigator must have studied carefully this coding, to verify that the answers will allow it to be easily entered into the database.

Speech

It is sensible for the investigator to adopt a level of language similar to that of the interviewee for a better understanding and to adapt his speech to the capacity and the personality observed. This process has the advantage of motivating the verbal productions of the interviewee by relating to them.

Giving to the interview the feeling of a conversation allows it to pass from one theme to another naturally by the association of ideas. Although the order of the themes may not reflect that of a formalised check list, being well linked in the conversation may foster a more natural environment to encapsulate the details from an interviewee as long as all the themes are covered.

Professionalism

D2.3 Training Package including training manual and draft protocols

The investigator may be regularly confronted with uncomfortable feelings depending on the nature of the accident. Meeting with interviewees who are in distress after recently being involved in a traffic accident, it is sometimes difficult to assume a professional investigation approach. Therefore, investigators must conduct themselves professionally, in such a way that they can overcome any anxiety or nervousness. It is essential to remember that the primary motive of the investigation and the investigator is to collect relevant data to better understand the accident.

Testimony Reliability

The verbal testimony of the road user involved in the accident is essential for the reconstruction of events and analysis of the accident. It is therefore advisable to be aware of the various biases which can be found in the statements of involved road users. The analysis of these statements thus requires a certain caution, as inaccuracies and distortions (deliberate or not) can occur at various levels. Some sources and examples of bias to be considered are detailed as follows:

- The Forgery: the road user deliberately gives a version of the facts which releases him from the responsibility. It is here that the ability of the investigator to acquire the trust of the interviewee about the confidentiality of the data which is collected is important.
- The Justification: the road user tries to prove, to others and themselves, that their behaviour obeyed a certain logic, coherent with the capacities of a "good driver", protecting implicitly their actions.
- They can sometimes persuade themselves that what was had envisaged beforehand as a hypothesis is fact.
- The Rational Reconstruction: the user reconstructs the chain of his actions from the elements which he memorized, but he involuntarily fills in the gaps by resorting to his mental representation of his task and his usual ways of functioning.
- The Bias of Analysis: the gap between the declarations and the facts can also be revealing mechanisms of errors with which were confronted by the persons. Such inaccuracies are of interest from the point of view of the understanding the difficulties really met by the interviewee in situations, in regards to their perception and interpretation of the process.

Certain inaccuracies are thus voluntary and many others unconscious. The experience of the investigators is paramount in the ability to disentangle these various biases in the speech and to allow them to grant more or less credit to the narrative of the road users.

9. Medical Data

The purpose of medical data is to collect and code injury data (according to the Abbreviated Injury Scale) and perform injury mechanism analysis – to classify accidents by medical injury severity and allow analysis on the potential for injury reduction. Database entries are to be made fully anonymous, without any personal names, addresses or vehicle registration numbers included.

All Teams

- Note Police recorded injury severity for each person involved.

D2.3 Training Package including training manual and draft protocols

- Attempt, with permission, to collect medical records from hospitals or other appropriate sources (e.g. pathologist or doctors) and describe the injuries.
- To follow all necessary ethical and data protection procedures both in the acquisition, processing and storage of any information on both paper or electronic media.

Developing and Experienced Teams

- Code injuries according to AIS 2005 (update 2008) manual by trained medical personal.
- Carry out a case by case analysis of the possible mechanisms or causes of injuries.

Arrangements

All Teams

- Ethical approval if necessary.
- Consent forms to obtain medical records including routines on how to send and receive these forms.
- Agreement with local hospitals to access medical records.
- Please note: the DaCoTA training programme will cover the collection and basic description of injuries, but will not be able to provide authorised AIS training. Additionally, it is recommended that at least one investigator from each team should receive official AIS training and acquire the necessary manual.
- A list of authorized training organisations can be provided upon request.

Experienced Teams

- Fully trained and experienced medical personnel for AIS coding and analysis of the causes of injuries.

10. Accident Causation

The aim of the accident causation section to to outline how to use the DREAM methodology to analyse and code the cause of each accident in a uniform and comparable way.

All Teams

- When all relevant pre-crash information is collected the DREAM method is used for categorising contributing factors.
- Reconstructions can validate the result.
- One DREAM analysis is completed for each road user such as driver, powered two wheeler rider (driver), pedal-cyclist and/or pedestrian (not passengers) regardless of blame.
- Enter the DREAM codes in the database system.

D2.3 Training Package including training manual and draft protocols

The Driving Reliability and Error Analysis Method (DREAM) was first developed by Ljung and later developed in the EC SafetyNet project to make it possible to systematically classify and store accident causation information which has been gathered through in-depth investigations by providing a structured way of sorting the causes behind the accident into a set of formally defined categories of contributing factors. The methodology has since been further developed, including updates for use in the DaCoTA project.

Arrangements

All Teams

- Training and support from the DaCoTA partnership.

11. Accident Reconstruction

The purpose of the accident reconstruction is to allow investigators a better overall understanding of the accident event. An accident reconstruction involves investigation and analysis of an accident and the eventual drawing of conclusions that may provide investigators insight into contribution accident causation factors and resulting collision analysis.

The resulting data and analysis from an accident reconstruction can be used to improve the overall safety for vehicles, road infrastructure and road users.

All Teams

Accident reconstructions are instrumental in conducting an accident analysis. Furthermore, they also require specialist knowledge which all teams may not have access to. Therefore, to ensure that all accidents can be reconstructed (possibly by another team or an analyst using the data) it is important that all teams collect the required data to perform reconstructions accurately. Much of the data collected is merely useful when performing reconstructions, whereas other data is crucial and must be collected whenever possible, with high quality. Such vital information includes:

- A scaled sketch containing all relevant data
- Pictures of road layout, road user paths, traces, collision objects and vehicle deformations
- Information from the road users of their account of the accident
- A sequence of events according to the investigators
- Deformation measurements of the vehicles

Developing and Experienced Teams

As the investigation teams gain more experience, they will be able to find and interpret information useful for the reconstruction more efficiently. Examples of data that the teams should try to collect in addition to what is mentioned for all teams are:

- Roll over direction and number of rolls based on impact marks
- Braking or no braking based on deformations
- Basic speed assessment by the use of simple equations.

D2.3 Training Package including training manual and draft protocols

- Delta V based on energy based reconstructions

Experienced teams

The experienced teams should not only be able to collect and interpret all the information but use it for full reconstructions using specialized software. In cases where not all data could be collected the investigator will have to determine if the missing data can be replaced with estimates or if it is not possible to do a reconstruction. Based on the result of the reconstruction other collected should be reviewed and discussed if not in line with the reconstruction.

An accident reconstruction is based on three laws of physics, which have to be used by the investigator in order to define parameters, such as initial speeds and post crash speeds. These laws can be used separately (if only one variable is unknown) or combined (if more variables are unknown).

Newton's First Law of Motion

Every object in a state of uniform motion tends to remain in that state of motion unless an external force is applied to it.

Newton's Second Law of Motion

The relationship between an object's mass 'm', its acceleration 'a', and the applied force 'F' is 'F = m x a'. Acceleration and force are vectors in this law and the direction of the force vector is the same as the direction of the acceleration vector. 'F' is the acting force, 'm' the mass of the body and 'a' is the acceleration of the body due to the acting force.

Newton's Third Law of Motion

Action and reaction are equal and opposite, i.e. when two bodies interact, the force exerted by the first body to the second body is equal and opposite to the force exerted by the second body on the first. Newton defined the collision into two phases: the compression and the restitution phase. In case of a full impact, at the end of the compression phase, the velocities of both vehicles at the impulse point are identical. Due to elasticity of the vehicle structures, the two vehicles will separate again.

Conservation of Energy

The conservation of energy states that the amount of energy in a closed system is constant, regardless of the changes in form of that energy. Energy can neither be created nor destroyed. Therefore the kinetic energy before the impact equals the kinetic energy after the impact, in addition to the energy loss. where:

m = the total mass of the bodies

v = the body velocities

i and j = the bodies involved in the crash

Energy can be lost during the impact due to:

1. Deformation of vehicles
2. Rotation of vehicle
3. Friction between tyres and pavement

4. Sound due to impact

The energy loss due to deformation is more significant than the other values, as its magnitude is much greater than the other losses. The other losses are difficult to define, because of unknown parameters (e.g. duration of impact, moments of inertia of vehicle, centre of gravity of vehicle). Since they are typically one order of magnitude smaller, they are most often neglected. A parameter, which is commonly used to define the deformation energy loss, is the Energy Equivalent Speed (EES). The reconstruction parameter EES will be described later on. There are crash test databases (the NCAP database for example) from which the EES can be obtained.

Principle of Linear Momentum

Momentum is the product of inertia and velocity. During any collision, momentum is conserved as a consequence of Newton's 3rd Law - the Law of Action-Reaction. Momentum is the tendency of an object in motion to stay in motion. Thus, the total momentum before a collision is always equal to the total momentum after a collision.

A useful way of increasing the applicability of the above mentioned equation is by using the concept of elasticity. Elasticity is a measure of the ratio between the separation and final velocity. It can vary between 0 (fully elastic impact) and 1 (plastic impact, no separation).

Principle of Conservation of Angular Momentum

Angular momentum is the tendency of a rotating object to keep rotating at the same speed about the same axis of rotation.

12. Case Delivery

The purpose of the case delivery section is to detail how the investigation findings should be organised and recorded in the DaCoTA database system. The case delivery section attempts to ensure that investigation teams enter sufficient case related data into the database after their investigation, so as to provide the necessary data to perform an analysis and reconstruction for the accident in question.

The DaCoTA system is an internet based open source cross-platform web application that allows users to enter variously formatted data (i.e. text, pictures, sketches, files, etc.).

- The DaCoTA database system attempts to:
- Store and organise in-depth accident data in a harmonised fashion
- Provide an environment to filter and analyse the collected accident data
- Enable a secure method for DaCoTA partners to share data and analysis

Methods

The methods outlined within this section should be applied in conjunction with relevant Detailed Methodology sections.

1. Appoint a Case Leader

Determine the most suitable team member to be responsible for controlling the quality and completeness of the dataset entered. The case leader will ideally be the DaCoTA_D2_3_training materials_Final.doc

D2.3 Training Package including training manual and draft protocols

most experienced team member on the investigation team. A more experienced Case Leader should better understand what is required from an investigation and familiar with the core variables to be entered into the database.

2. New Case

The case leader should then open a new case in the DaCoTA database. The Case Leader should then liaise with the investigation team to allocate specific responsibilities to each member.

Entering in collected data into the DaCoTA database can now begin. The Case Leader should ensure that the core variables have been entered. Furthermore, the data should be reviewed by the Case Leader to check the quality thereof.

3. Additional Considerations

Once the collected data has been entered into the database and it has been reviewed by the Case Leader for quality and completeness, the Case Leader must decide whether an additional retrospective investigation is required. A subsequent investigation may be required to procure additional evidence in order to create a more complete dataset.

Furthermore, the Case Leader is responsible to ensure that all data is made anonymous. All identifiers should be removed from data (licence plate numbers, road user names, addresses, Vehicle Identification Numbers, etc.).

13. Equipment List

The purpose of the Equipment List is to compile all individual equipment lists into one comprehensive list for reference purposes.

This list is subdivided into the various Detailed Methodology tasks. Before accident investigators begin any one of these tasks, it is recommended to consult the relevant Equipment List section to ensure they are properly equipped and able to perform the requirements of the task.

Health and Safety

- Personal Protective Equipment (according to Directive 89/686/EEC):
 - Steel toe capped footwear
 - Reflective jacket
 - Gloves – heavy duty (anti-tear) and disposable
 - Safety glasses
 - Safety helmet
 - Face shield
 - First aid kit
- High visibility reflective items and lights for investigation vehicle

D2.3 Training Package including training manual and draft protocols

Accident Notifications

- Sampling plan and local maps (GoogleEarth/Maps and GoogleStreetview) – to check notified accidents are within the agreed geographical boundary
- Mobile phone, smartphone, tablet PC or similar for receiving notification when the team is away from the office

Scene and Road

The Scene and Road equipment list also applies for the Photo Routine, Scene Measurements and Scene and Road Sketch tasks.

- Checklist (based on the database)
- Permit or memorandum of agreement for in-depth research of road authority or police, driver license, vehicle registration document
- All Health & Safety equipment
- Investigation vehicle (appropriately marked for visibility and equipped with flashing lights)
- Measuring tapes
- Folding staff
- Spray chalk
- Thermometer
- Digital camera (with video capabilities)
- Spare camera batteries
- Spare memory card for camera
- Camera tripod
- Toolset
- Flashlight
- Inclinator
- Measuring wheel
- Digital laser distance meter (incl. digital inclinometer)
- Tripod for laser distance meter
- Torch
- Level
- Levelling rod
- Grade rod
- Note taking items (pen, pencil, paper, etc.)

D2.3 Training Package including training manual and draft protocols

- Marking cones
- Safety gate
- Traffic signs: road works, speed limit, right of way by narrowing road
- GPS
- Scaled paper for making hand sketches

Vehicle Inspection

- PPE
- Tyre pressure gauge
- Tread depth gauge
- Stands and rulers for measuring deformations
- Digital camera
- Magnetic arrows to indicate small marks/deformations
- Investigation vehicle

Vulnerable Road User

- Please refer to the Vehicle Inspection equipment list.

Behavioural Data

- Phone with headset
- Interview guide
- Recording equipment (where legal, appropriate and consented)
- Questionnaires (to send in the post, when required)

Medical Data

- Abbreviated Injury Scale (AIS) 2005 (update 2008) Manual
- Anatomical references
- Secure storage (for all medical related data)

Accident Causation

- Coding database system
- DREAM manual (DaCoTA update)

Accident Reconstruction

- Appropriate software (i.e. AI Damage, PC-Crash, etc.)

Case Delivery

- A computer system and internet connection (capable of running the DaCoTA database system)

1.6. Forms and Documents

The following tools can be found in the on-line manual:

- Accident Inspection Form
- Bicycle Inspection Form
- Car Inspection Form
- Draft Telephone Interview Script
- On Scene Accident Form
- On Scene Sketch Form
- On Scene Interview Form
- PTW Inspection Form
- Reconstruction Form
- Road Inspection Form
- Road User Child Form

The forms are blank and can be used or adapted by the investigation team to collect data in a systematic way.

2. TRAINING PACKAGE

2.1. Introduction

A training package was created by the DaCoTA partners to facilitate the training of the investigation teams who are members of the Pan-European In-depth Accident Investigation Network.

This training package was initially delivered during the DaCoTA training week that was held between the 12th – 16th March 2012 in Santa Oliva, Spain. The following topics were included in the training:

- Preparing an Investigation Team
- Scene Examination and recording visual evidence about the crash scene
- Vehicle Examination
- Vulnerable Road Users
- Collecting Road User Data
- Medical information
- Case Analysis

The following sections provide a summary of each of these topics. Annotated copies of the corresponding presentations that were delivered during the DaCoTA training week can be found in the appendix. Please read both these sections and the presentations concurrently as all relevant information is presented within both of these sections together.

2.2. Preparing an Investigation Team

Objectives

This part of the training deals with readying the teams to be able to do in depth accident investigations. This section outlines what steps the teams need to put in place to develop team structure as well as adhere to the health and safety guidelines when conducting on scene accident investigation work.

Scope of the training

This section of the training is divided into three subsections.

1. Preparing to make in depth investigations

This section will concentrate on identifying the different methods of crash investigation and how these methods are to be carried out according to the DaCoTA methodology. The different stages of a crash investigation are outlined and highlighted. The three possible methods for crash investigation with the DaCoTA method are;

- Mass data analysis
- Retrospective crash investigation
- On scene crash investigation

This section will also discuss the different sampling requirements for different data types and how to undertake these sampling requirements.

2. Infrastructure, relationships and data management

In this section the necessary local area infrastructure developments will be discussed, as well as the relationship requirements with emergency services and tow truck/garage services. The necessary ethical approval requirements for conducting crash investigation research will also be highlighted. Data management and protection issues will also be discussed.

3. Personnel, training, equipment and team health and safety

This section will discuss team requirements within DaCoTA, what skills these team members need to have and the equipment that is necessary for the team to take on site.

Health and safety requirements for the team whilst travelling to the scene, arriving at and preparing the scene, doing the on scene and post scene work will be described in detail.

2.3 Scene Examination and recording visual evidence about the crash scene

Objectives

This part of the DaCoTA-training on in-depth crash investigation deals with scene/site examination and recording visual evidence about the crash scene. The aim of this part of the training is to provide information and practical training on how to document the crash scene. During the training and in the related documentation, a distinction is made between the actions needed when carrying out – the preferred – on-scene investigations and the actions needed when carrying out retrospective investigations.

Scope of the training

Important elements of the training on scene/site examination are:

- Recognising and recording traces on the scene
 - Recognising and interpreting different types of marks, such as those from tyres, material and biological marks
 - How to mark traces
 - How to take (good) pictures of traces
- Taking measurements of the crash scene (road layout, position of vehicles)
- Taking photographs of the scene and important elements (sight restrictions, obstacles, roadside) and videos of the approach, and sanitising them to make sure that the people and vehicles involved are not recognizable
- Documentation of measurements
- Drawing a scene plan or sketch

Presentation

The training on scene/site examination started off with a presentation. In this presentation, the emphasis was on recognising and interpreting different types of traces, taking pictures and sanitising them, and on methods to take measurements of the road layout (coordinate system and triangulation).

Practical session

After the presentation, participants went outside to examine a simulated crash scene. They were shown how to mark traces, how to measure a straight road section and how to incorporate all relevant items (roads, vehicles, skid marks and debris) in a scene sketch. At the end, participants were asked to make their own sketch of the crash scene.

While walking to the simulated crash scene and back, the trainers discussed several of the road elements (e.g., sight restrictions, obstacles in the roadside) and traffic situations (roundabouts) in the immediate surroundings of the training location. The trainers showed how they can be of relevance for crash and injury causation and how they should be documented.

Database and wiki

Participants were shown how information gathered on the road should be entered in the database and where additional information on how to carry out a scene investigation can be found (Online Manual: Detailed Methodology, Scene and Road).

Available documents on scene/site examination

- Presentation on scene/site examination & recording visual evidence about the road scene
- Methodology outline on Scene and Road
- Detailed methodology on Scene and Road
- Detailed methodology on Photo routine (scene and road photos)
- Accident inspection form
- On-scene accident form
- On-scene sketch form
- Road inspection form

2.4. Vehicle Examination

Objectives

The recording of vehicle data from accident participants is structurally integrated in the DaCoTA Database as elements of different types of road users which can be added to an accident case. For each type of road user specific data with the specific variables can be added.

The types of road users which can be added to a case are:

- Cars, trucks, busses (as vehicles with occupants); and
- Pedestrians, bicycles, powered two-wheelers (as vulnerable road users)

The training on vehicle examination for team members willing to collect accident data according to the DaCoTA methodology is split up into those two parts: Vehicles with occupants and vulnerable road users. The training on both parts included an initial session for theoretical training on the data to be collected and entered into the database and a session for practical training where the trainees exercised the data collection from real vehicles (some with deformations)

Scope of the training

Vehicles with occupants

The examination of vehicles with occupants is clearly focused on cars as the time and resources for training are limited and as cars are the most common type of road users found in vehicle accidents and account for about 60% of all road users (German situation according to GIDAS). Only about 6% of the road users involved in accidents are Trucks and only about 2% are buses.

Theoretical training on examination of vehicles with occupants

With the focus on cars the theoretical training gave an overview over the methodology for vehicle examination (see the Appendix: Training Presentations, Vehicle Examination).

For data collection the necessary information to be gathered is shown along the structure of the database (see the Appendix). For cars the database offers 7 different pages for entering information according to the 7 different categories of car related data: Administration, General, Impacts, Exterior, Interior, EDR, Safety systems. Some of these Categories may have sub-categories in the form of different tabs to be selected. For example the category "Exterior observations" of vehicle data is subdivided into four different tabs: General information, doors and glazing, information about the wheels and information about a possible trailer.

As the DaCoTA Database shall be a tool for data collection for both experienced investigation teams and less/in-experienced investigation teams a set of "core variables" was defined for all the records of the database. These core variables define the most important information to be gathered and describe the set of variables which should be collected by all the teams, independent of their level of experience. More experienced teams may go beyond this basic level of information and may collect the additional variables.

D2.3 Training Package including training manual and draft protocols

The following categories of data should be collected for the element 'car'. These categories present different pages and will be available for data entry in the database and will be indicated by tabs at the top of the screen:

1. Administration

The category of administration includes information on when the vehicle examination was done and by which member of the accident investigation team. All variables are core variables and need to be collected.

2. General

In this category general data concerning the car is collected. This category is divided into two parts. The first part (tab "1") allows entering vehicle specific information concerning vehicle identification, make and model, fuel and powertrain of the vehicle and as non-core-variables information on the condition of the vehicle before the crash. All variables are self-explanatory with the help of the DaCoTA online codebook based on the "Wiki" environment and need not be further mentioned. The second part (tab "2") of this category allows information to be entered regarding the mass of the cargo transported by the vehicle. This information is important for its influence on vehicle dynamics and for accident reconstruction, which will be addressed during the training

3. Impacts

The category "impacts" allows data to be collected on the crash related deformation of the vehicle or on crash related marks from pedestrian contacts. In the sub-category "General" various impacts can be added to each vehicle with deformations on various parts of the vehicle. Additionally the Collision Deformation Classification (CDC) and the deformation measurements C1-C6 along the width of the deformation are collected in this tab for each impact. This information makes up the core variables for entry of vehicle deformation data and this is most commonly used in accident research. Therefore coding of these variables was addressed during the theoretical training session. The sub-categories "Frontal", "Rear", "Left side", "Right side", "Top" are for collecting more detailed information on the deformation due to the corresponding impact such as deformation of sills or other parts of the vehicle's main structure. These variables do not belong to the core information and were not explained thoroughly. However the collection of this data was also addressed briefly in theory. The last sub-category of "Impacts" is related to the collection of pedestrian contact marks. As this information is core information, pictures of possible contact marks were shown, and the entry of this data (x-, y-, z-measurement and wrap-around-distance) was explained in the database.

4. Exterior

Observations of the exterior of the vehicle contain only some core variables. In the first sub-category ("General") only the information on fire and marks from extrication or from towing-away of the vehicle are core variables. The other variables in this sub-category are self-explanatory and easy to collect for experienced teams. This applies also to the sub-category on "doors and glazing" of the car and to the sub-category on information about a possible trailer. The sub-category on the "wheels" of the car however includes core information such as the Axle distance differences and information from the tyres. With the help of an example the nomenclature of tyre specifications were explained in the theoretical training session.

5. Interior

D2.3 Training Package including training manual and draft protocols

Observations of the car interior all belong to the group of core variables and are divided into 4 sub-categories. The first sub-category "General" allows the entering of basic data on the deformation of the steering wheel and on longitudinal deformations on the dash panel and foot well area. The second sub-category includes data on the seat and seat belt of each passenger in the car. Identifying the seatbelt code and friction marks as part of the seatbelt variables shall be explained with the help of example pictures. Data about the availability of airbags and their deployment is collected in the sub-category "Airbag". In this subcategory for each car occupant the location of different types of airbags can be indicated together with the information on whether they deployed or not. Further interior observations such as impact marks from occupants can easily be added to the database by describing the mark or observation and by indicating the exact position on a pictogram of a car interior.

6. EDR

Data from an EDR (Electronic Data Recorder), which records the movement of the vehicle and the actions of the driver for a time span before the crash is (still) very rarely available and therefore was not categorised as core information.

7. Safety Systems

The information about active safety systems and driver assistance systems is entered under the category "Safety Systems". These variables are core variables and collect important information for the pre-crash phase. It has to be pointed out, that the difficulty lies in finding out the availability of the systems and even more in analysing whether or not they were functioning before the accident.

In addition to cars, data collected for trucks will be a rudimentary part of the theoretical training. As the structure of data entry for trucks is similar to that of cars only a few variables will be addressed, such as the description of the complete vehicle combination or the collection of data on the driver's vision from inside the cabin.

Practical training on examination of vehicles with occupants

The session of practical training on vehicle examination was held at an outdoor site at IDIADA with the opportunity to practise data collection on some cars which have been used for an experimental crash reconstruction.

The cars available have principal deformations due to a front impact and a side impact. In the practical training the emphasis was on the demonstration and the exercise of collecting the principle and core vehicle deformation information such as the CDC and deformation measurements C1- C6. As the crash reconstruction with the available cars was performed with human dummies inside the car, the existence of contact marks from the dummies in the vehicle interiors and crash related marks on safety systems like the seat belt were also demonstrated. Furthermore artificial marks of a pedestrian contact were put on the vehicle body practise the collection of data recorded under the sub-category "Pedestrian" in the category "Impacts" of the database. The vehicle deformation data which does not belong to the core set of variables was also demonstrated during the practical session.

2.5. Vulnerable Road Users

Objectives

The training module on VRU inspection and recording of visual evidence is a sub-module under the second module to be delivered during the DaCoTA training week. This training section includes an overview of the information which needs to be collected in order to complete this specific section of the database and will provide practical exercises on collecting important basic information. All types of VRUs are included in this module, while the focus will be on collecting information from motorbikes, bicycles and restrained children.

Scope of the training

The scope of the training session is summarized below:

- Introduce participants to the database, focusing mainly on the most complex variables in terms of definition and information collection
- Record the technical specification of a vehicle, including the identification of special systems (e.g.: ABS, adaptive head lights)
- Recognise and record traces on vehicles (e.g.: skid marks, scrape marks, human body contact areas)
- Describe techniques to capture traces in pictures
- Measure the deformation of a vehicle (wheelbase reduction)

Presentation - Field training

The training will be split up into two sessions on that day: A theoretical session in the beginning which consists of some presentations, and a practical session where the group of trainees will have the possibility to see and examine real vehicles on an outside field.

Information provided in the presentations of the Theoretical session

- An overview about the elements of the database referred to in this module
- Short summary on the methodology of vehicle examination
- Recording of visual evidence on vehicles
- Outline of the data which needs to be collected for PTW, bicycles and children (as car occupants).
- Special example on coding of vehicle deformations
- Examples of PTW damages and traces
- Safety measures to be taken during vehicle examination

Field training

For practical reasons the group of trainees were split into two groups for the outside session and each group took part in a training session on data collection from cars and a training session on collecting data from vulnerable road users and buses at different times.

D2.3 Training Package including training manual and draft protocols

1. First Practical session outside: Collecting data from cars (see vehicle examination session)

2. Second Practical session outside:

- Collecting data from vulnerable road users
- General vehicle examination for motorcycles and pedal-cycles, including photography
- Identification of vehicle safety features (ABS, Traction Control, adaptive lights)
- Vehicle examination: whether tyres or rims (and other vehicle parts) were damaged due to the accident, checking for locked-wheel tyre marks, scrape marks and cracks
- Helmet inspection and description of the most common marks/damage on helmets (example crash helmets available)
- Protective equipment inspection (upper and lower, boots and gloves). Examples of damaged protective equipment will be available for inspection too
- Child Restraint Systems inspection

Database and Online Manual

The training team will demonstrate to the attendees the relevant Wiki sections and the instructions they have to follow in order to correctly and commonly collect and codify the requested information. The data collected during the practical session will be entered in the database at the end of the day.

Available documents for vehicle/VRU examination

- Presentations on VRU examination and data collection
- Methodology outline on Vulnerable Road User (VRU) Data Collection
- Inspection forms:
 - PTW, bicycle and child (restraint system)
 - Vehicles/Equipment/Tools
 - Photo cameras and tripods
 - Measuring tapes, scaled rulers
 - Tyre pressure and profile depth gauges
 - Helmets, jackets, footwear, gloves
 - Child restraint systems
 - Motorbikes, bicycles

2.6. Collecting Road User Data

Objectives

Verbal data collected from road users involved in an accident aims to get information in the same way as the more objective data collected on the field (road, vehicle, etc.). This promotes a more precise description of the facts and their involvement in the accident process. Information from road users will allow the investigators to better understand and explain the accident mechanisms and eventually to confirm the material data.

The purpose of the DaCoTA sixth training module dealing with “collecting Human Behavioural Data” is to give both general statements and practical clues for getting information from drivers and witnesses, taking into account the unique accident context.

Scope of the Training

The main points covered in the training will concern:

- Interest and value of verbal data to understand: 1) the state of the driving system in which the accident took place, 2) the characteristics of the different components involved (road, vehicle, drivers, traffic, weather, etc.), 3) the course of events (in the pre-accident situation, the rupture situation, the emergency situation, up to the crash phase), 4) the difficulties met and errors committed by the different participants and their perception of these difficulties, and 5) the different patterns of elements (factors) having contributed to the emergence of these difficulties.
- Ethical questions that have to be considered are: 1) personal consent, 2) confidentiality, 3) anonymisation of personal data, whether direct (speech, names, etc.) or indirect (images, names of street, dates, etc.), 4) storage and protection of the data.
- The question of reliability and the potential bias connected with verbal information
- Element of method on how to collect the information (face to face interviews, on the phone interviews, questionnaires)

Training Course

The training method will consist of both an overall presentation with discussions, and a practical session on how to conduct interviews in the frame of an accident's context. The specificity of face-to-face interviews, interviews on the phone and questionnaires will be further developed.

Key DaCoTA Documentation on Human Behavioural Data

- Presentation on Human Behavioural Data
- Methodology outline: Behavioural data
- Detailed methodology: Behavioural data
- Interview Guidelines
- Draft Telephone Interview Script
- Prompts on the scene
- Draft Telephone Interview Form
- On Scene Interview Form

2.7. Medical information

Objectives

The collection of medical information from the victims involved in the crash is an essential component of DaCoTA. The goal of this section is to describe the different available sources of medical data, showing their advantages and shortcomings. The Abbreviated Injury Scale (AIS) is discussed at length since it has become the most used injury severity scale in road traffic research. Other scales used to measure the severity of injuries are also covered in this section. A brief introduction to some key anthropometric and biomechanical parameters follows. This training module continues by showing a few examples of real crashes and how the detailed analysis of the interior of the vehicle and the performance of the restraints can help to understand the occurrence of specific injuries. The special case of vulnerable road users is the focus of the last part of the module.

Scope of the training

This training module will cover the following topics:

- Introduction to collecting injury data
- Why is it so necessary?
- Different sources of injury data
- Introduction to injury coding
- The International Classification of Diseases (ICD)
- The Abbreviated Injury Scale (AIS)
- Scales derived from the AIS: MAIS, ISS, NISS
- Other scales used in the field
- Identifying the causes of injuries
- Anthropometry
- Injury criteria
- Vehicle interior inspection
- Vulnerable road users

At the end of the session, the attendees should be familiar with different potential sources to collect injury data and with different scales that measure the severity of injuries. The participants should understand why collecting injury data is an essential part of road traffic safety.

Presentation

This training session consists of a presentation on the topics indicated above. The slides will be shared with the participants.

D2.3 Training Package including training manual and draft protocols

Database and wiki

The participants will be shown a practical case in which the medical information of the victims involved in a real-world crash will be entered in the DaCoTA database.

Available documents on scene/site examination

Presentation on Medical Data Collection and Analysis

Methodology outline on Medical Data Collection and Analysis

AIS 2005 (update 2008) manual.

2.8. Case Analysis

Objectives

The training module on Accident Reconstruction aims at introducing the attendees to different methods of accident parameters' calculation (trajectory analysis, dV based, energy or momentum based). The reconstruction of a road traffic accident can be performed in different levels, where the primary level is the analysis of the vehicle kinematics and the impact dynamics. With knowledge of the vehicle trajectories, occupant kinematics and impact dynamics can be calculated. Further study of impact dynamics leads to the field of injury mechanics.

The outcome of an accident reconstruction delivers information about the awareness and reaction of the road users, in case of a driver the steering and braking behaviour previous to the crash, their paths, the collision point and the velocity at the respective positions. There is not a specific set of required input parameters and the available information is used to calculate the unknown parameters. If there is a lack of known parameters from accident data collection to solve the physical equations then assumptions can be made. But this may result in low confidence in the reconstruction outcome.

For an accident reconstruction there are three different phases of the accident, where different sets of physical equations can be used:

1. The pre-impact phase starts with the conflict point and ends with the contact between the collision opponents.
2. The impact phase includes the contact time span between the vehicles.
3. The post-impact phase starts with the separation of the conflicting opponents and ends when all of the opponents have no kinetic energy left, they are at a standstill (rest position).

Not all reconstruction methods will deliver a full description of the dynamic state/trajectories of the participants involved in the accident. With a subset of specific parameters it may be possible to generate only partial results. One example here is the calculation of the change of velocity (ΔV) in the crash, when only the deformation pattern of the collision involved vehicles is measured. The deformation energy is calculated from generic stiffness models and with the assumption of a specific coefficient of restitution and energy distribution between the opponents. From this calculation the ΔV can be retrieved. Nevertheless it is important to notice that a reconstruction always delivers a range of possible solutions, and not an exact value. If single values are given, they represent a mean value with a standard error distribution.

Scope of the training

The scope of the training session is:

- A summary of all necessary input (e.g.: sketch, vehicle measurements, interviews)
- Speed calculation by using the length of skid/sliding/scrape marks
- Energy based calculations by using the vehicle deformation already measured
- Momentum based calculation principals
- Trajectory analysis-Pedestrian kinematics

D2.3 Training Package including training manual and draft protocols

- An introduction of accident reconstruction software (Ai-Damage, PC-Crash, VCrash)
- Demonstration of impact parameters' calculation from a two-passenger car crash test

Training Course

Presentation

The training course will start with an introduction to the information required to perform an accident reconstruction. There will be a short description of the methods to determine accident parameters such as speed and acceleration/deceleration. The estimation of speed and time by using the skid/sliding marks will also be explained. Another part of the presentation will be the trajectory analysis method and the three phases that an accident is normally divided into (pre-, crash and post-). Different reconstruction software will be shown to the attendees. For better understanding of the accident sequences, real life accidents captured in videos will be presented (e.g.: PTW, pedestrian)

Training Course Practical Session

The participants will attend the virtual reconstruction of a real life crash test and the mathematical results for the various test parameters will also be discussed.

Database and On-line Manual

Back in the auditorium, participants will be shown how Reconstruction results should be entered in the on-line database. Additional information on accident reconstruction can be found in the on-line manual.

Available documents for vehicle/VRU examination

- Presentations on Accident Reconstruction (theoretical and practical part)
- Methodology outline on Accident Reconstruction
- Accident Reconstruction form

Equipment/Tools

- Accident reconstruction software (Ai-Damage, PC-Crash, VCrash)
- Crash test videos

3. APPENDIX TO THE TRAINING PACKAGE

3.1. Training Presentations

This appendix contains copies of the presentations given as part of the DaCoTA training week:

Preparing an Investigation Team	1-74
Scene Examination and recording visual evidence about the crash scene	75-144
Vehicle Examination	145-211
Vulnerable Road Users	212-245
Collecting Road User Data (Human behaviour)	246-278
Medical information	295-376
Case Analysis	377-387
The DaCoTA online manual	388-395
Pan-European in depth accident system	396-411
Collision Reconstruction	412

Preparing to Make In-depth Investigations

Julian Hill
Transport Safety Research Centre
Loughborough University

Preparing to Make In-Depth Investigations

1. Methods of Investigation & Sampling
2. Infrastructure, Relationships & Data Management
3. Personnel, Training, Equipment and Team Health & Safety

1. Methods of Investigation & Sampling

Real-world Investigations



Crash Phases and the Key Factors

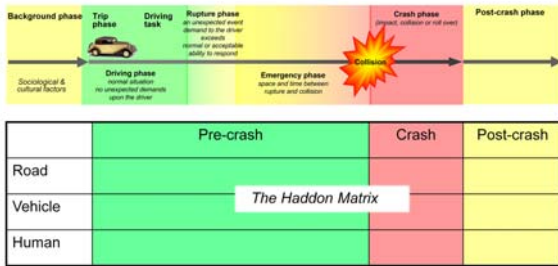

This slide demonstrates the Haddon Matrix with the different crash phases. It outlines the different stages that road users go through before a crash occurs.

5

DaCoTA Methods of Crash Investigation



- Mass data analysis
- Retrospective crash investigation
- On-the-scene crash investigation

This slide lists the different crash investigation types.

6

DaCoTA Retrospective Investigations

- Follow-up investigations, in-depth
- Vehicle crashworthiness
- Occupant Injuries
- Cost effective



This slide lists the different types of retrospective investigations for traffic crashes

7

DaCoTA Stages in Retrospective Investigations

- Crash occurs, occupants seek medical treatment in hospital or at GP etc.
- Vehicle towed from scene
- Investigating team receives notification
- Engineer/crash investigator follows up at recovery-yard
- Medical data coordinator follows up with patient hospital records
- Best-evidence synthesis of all case information

8

Stage 1 - Crash Occurs



Stage 2 – Medical data collected



Stage 2 – Medical data collected



Stage 3 – Vehicle examination





Case Details



OCCUPANT FEATURES

- personal characteristics (including seatbelt status)
- Police injury severity classification
- AIS 98 injury severity classification

VEHICLE FEATURES

- direction & extent of damage
- deformations & intrusions
- delta-V and EES
- source of injury



Vehicle Exterior



- CDC = 12FYEW3
- Max crush = 400mm
- Delta-V = 29km/h
- EBS = 29km/h
- Bonnet - jammed
- Longitudinals - no direct loading but both bent slightly inboard
- Engine - contacted firewall, minimal displacement
- No damage to glazing
- All doors OK

This slide shows an example of a retrospective crash and its measurements



Vehicle Interior



- No intrusion in passenger compartment
- Steering wheel - slight distortion only
- Seats undamaged
- Brake pedal fully depressed
- Nothing else of significance



Restraints



- No airbags fitted in vehicle
- Driver belt heavily loaded by occupant - marks on tongue, belt webbing and D-ring. "Replace belt" tag showing.
- No evidence of other restraint use in vehicle



17

18



Contacts



- Heavy belt loading
- General damage to lower fascia area-cladding completely dislodged revealing bracketry and other 'hostile' elements
- Depression of brake-pedal
- Slight crack and skin tissue on steering wheel hub



Injury Descriptions

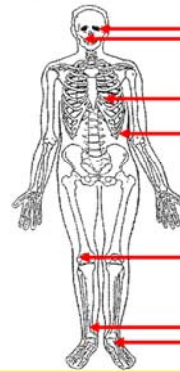

- Lacerations to left face
- Epistaxis (Nosebleed)
- Multiple left rib fractures
- Ruptured spleen
- Laceration to right knee (de-gloving)
- Right bimalleolar #
- Left medial malleolar #

This slide shows the injuries that occurred to the road user.

19

20

Injuries and Contacts

<i>Injury Description</i>	<i>AIS</i>	<i>Contact source</i>
Ruptured Spleen	5	Seat belt
Multiple #'s left ribs	2	Seat belt
Right bimalleolar #	2	Pedal foot roll-off
Left medial malleolus #	2	Foot-rest roll-off
Laceration to left face	1	Steering wheel
Epistaxis	1	Steering wheel
Subluxation of right patella	2	Lower facia
Laceration to right knee	2	Lower facia

This slide shows the injuries and Abbreviated Injury Scale levels for those injuries.

On Scene Investigations

- Perishable (volatile) data
 - trace marks & debris
 - vehicle positions
 - pedestrian & cycle contacts
 - weather
 - traffic



This slide show the different types of perishable data that are only possible to be obtained with on scene accident investigation.

On Scene Investigations

- Perishable (volatile) data
 - trace marks & debris
 - vehicle positions
 - pedestrian & cycle contacts
 - weather
 - traffic



On Scene Investigations

- Perishable (volatile) data
 - trace marks & debris
 - vehicle positions
 - pedestrian & cycle contacts
 - weather
 - traffic



On Scene Investigations

- Perishable (volatile) data
 - trace marks & debris
 - vehicle positions
 - pedestrian & cycle contacts
 - weather
 - traffic
- Interviews
 - witnesses
 - casualties



Casualties

- Position
- Injuries
- Interactions
- Clothing
- Helmets



This slide shows some of the different interactions that are required to be obtained from a road user.

Casualties

- Position
- Injuries
- Interactions
- Clothing
- Helmets



Casualties

- Position
- Injuries
- Interactions
- Clothing
- Helmets



Casualties

- Position
- Injuries
- Interactions
- Clothing
- Helmets



Vehicles

- Collision avoidance systems
- Lights
- Defects
- Crash structures
- Under-run guards
- Restraint systems
- Loads
 - restraint
 - movement



This slide shows some of the information that is required and only possible to obtain on scene for vehicles.

Highway

- Layout
- Safety features
- Meteorological conditions
- Traffic density
- Surface properties & contamination
- Signing, views & sight-lines



This slide shows what is possible to gather on scene for highway features.

Witnesses

- On-scene interviews
- Telephone interviews
- Postal questionnaires

This slide shows what is required to be shown for witnesses

DaCoTA **Importance of Statistical Sampling**

- Need to know if accidents are representative



- Help to set priorities and achievable targets

This slide demonstrates what is needed for statistical sampling in your region.

33

DaCoTA **Case Sampling Requirements**

- Each team needs to adopt a geographical area in which to operate
- Need to know the population of the area from which the sample are taken
- Need to know the number of accidents in the area as well as severity
- Ultimately need to reconcile the two and aim for representivity of the sample in respect of the area
- **But not for the 5 pilot cases...**

34

DaCoTA **Sampling Example – UK Perspective**

Region	Number of fatal crashes (a)	Number of Non-fatal Injury Crashes (b)	(a)/(b)
Whole of UK	3,621	310,506	1.1%
East Midlands	186	10,458	1.8%

This is an example of the East Midlands area compared to the whole of the UK for the On the Spot accident investigation project.

35

DaCoTA **DaCoTA Pilot Sampling**

- **Sampling for the initial pilot is less rigid than would be recommended for a full scale study**
- The DaCoTA Pilot Study investigation teams should produce at least five cases covering a range of different types of crashes, e.g. different:
 - crash configurations
 - vehicle types
 - road users
 - levels of injury severity

36

DaCoTA Pilot Sampling

- At least one case should involve a moving motor vehicle or pedal cyclist on a public road.
- Accidents selected may include fatal, seriously injured, slightly injured or non-injured road users.
- At least 3 out of 5 cases must include a road user who was taken to hospital immediately after the accident.

37

DaCoTA Pilot Sampling

- Accidents selected may include trucks, buses, cars, powered two wheelers, pedal cycles, pedestrians or other types of road users.
- The sampling area should have a clear geographical boundary in which the team has a high probability of obtaining all necessary information.

38

2. Infrastructure, Relationships & Data Management

39

What's Needed from the Local Area Infrastructure?

- Good relations with the local police force
- Working relationship with local hospitals for provision of medical data, access to in-patients etc.
- Good relations with local recovery/tow firms and insurance companies for access to vehicles

40

On Scene Coordination with Emergency Services



41



Access to Tow-yards and Recovery Garages

- In the majority of cases, vehicles will end up at a recovery or tow-yard
- Access to such recovery-yards is a crucial requirement so there is a need to foster good relations
- Never underestimate the power of biscuits!

42



Permissions & Ethics

- **To be covered in more detail on Wednesday**
- Access to names and addresses
- Consent for interviews
 - Can a person truly consent in a highly emotional state?
- Formal data sharing agreements
- Access to medical and coroners reports
- Access to police reports

43



Data Protection & Data Management Issues

- Must prepare for secure data storage BEFORE any data are collected
- Sanitisation of data – text and photos
- Each team should be aware of data protection considerations in own country
- How long can you store the data for?
- Who can access the data?
 - Staff
 - Police?
 - Involved road users?
- What are the procedures for access?

44



Record-Keeping

- Suggested that each team keeps their own data management records of key information
- Case number
- Location of investigation
- Investigation date
- Investigators
- Photographers
- Date of obtaining medical records
- Location of medical records
- Date of data entry
- Date of case despatch



Directorate-General for Mobility and Transport
Project co-financed by the European Commission, Directorate-General for Mobility and Transport

45



3. Personnel, Training, Equipment and Team Health & Safety



Directorate-General for Mobility and Transport
Project co-financed by the European Commission, Directorate-General for Mobility and Transport

46



Personnel



Directorate-General for Mobility and Transport
Project co-financed by the European Commission, Directorate-General for Mobility and Transport

47



Setting up a team for crash investigations

- Ideal
 - 2+ crash investigators with mechanical engineering / vehicle examination background
 - Reconstruction expert
 - Medical expert
 - Highways engineer
 - Psychologist
 - Support staff
- In reality.....
 - 2 crash investigators covering human, vehicle & highway data
 - Medical data coordinator
 - Clerical support staff

This slide demonstrates what the ideal team for crash investigation would be and what the reality of setting up a team is.

48

Training

Training

- This training week is a **basic** introduction to key knowledge and skills for collecting and coding data using the DaCoTA methodology
- Additional written materials including:
 - Online DaCoTA manual
 - DREAM manual
 - CaDAS manual
 - Other pre-read and handouts

Sharing the Knowledge

- As representatives of your team – you must take what you learn back to your colleagues
 - Ensure there is a mechanism / opportunity in place for you to do this, with adequate time allowed
- Please copy materials within your team
- If anything is unclear – check!

Additional Support

- You can request further support with specific challenges
 - Forum
 - Partner teams
 - Possible to run webinars or produce additional materials where necessary
 - Possible to discuss exchange visits between teams where permissions allow
 - Can recommend further training beyond the pilot (e.g. AIS)

Equipment

Essential Equipment and Other Considerations

- Personal Identification
- Investigation vehicle
- Tape measures/laser measures
- Stands and rulers for measuring deformations
- Digital camera and tripod (video camera optional)
- Variety of tools (sockets, spanners, screwdrivers etc)
- Useful 'things' – spray chalk, marker pen, scaled paper
- Good quality torch, flashlight
- Marking cones, warning signs
- Protective clothing (footwear, reflective jacket, gloves)
- Inoculations (Hepatitis-B, tetanus etc)
- Other health and safety equipment (glasses, disposable gloves etc)
- First Aid kit

Health & Safety

Health and Safety

- Documentation available
- Need to consider health and safety for the pilot study

But....

- Also for practical sessions this week

Team Safety Procedures

- Hazards identified in black
- Recommended control measures in **bold red italics**

PERSONAL SAFETY IS PARAMOUNT; IF A SITUATION DEVELOPS THEN PERSONAL SECURITY MUST TAKE PRIORITY OVER ALL ELSE.

Vehicle

- Movement of equipment whilst travelling.
 - **Equipment to be adequately restrained where necessary.**
 - **Emergency equipment to be readily accessible.**
- Using video whilst on the move.
 - **If using video camera in front passenger seat, operate airbag disable switch if fitted.**
- Injuries sustained in a crash.
 - **Seatbelts to be worn at all times.**



Travelling to scene

- Risk of involvement in a crash.
 - **Use of suitable vehicle.**
 - **Use of emergency lighting and warning instruments if appropriate.**
 - **Vehicle to be maintained in good mechanical order**
 - **Awareness of carrying large items in pockets when wearing a seatbelt.**



Arrival on scene

- Collisions from other vehicles.
 - **All team members to receive suitable on-scene safety training from the police and/or other credible organisations.**
 - **Team to liaise with the police officer to consider the need to close all or part of road.**
 - **High visibility personal protective equipment to be kept clean and worn at all times whilst on-scene.**
 - **Appropriate positioning of vehicle (fend off position).**
 - **Torches to be used at night.**



Making the site safe

- Intrusion of other moving vehicles into collision work area.
 - **Placement of cones & signs.**
 - **If necessary have someone alerting oncoming traffic ahead of potential danger of team on the highway.**
 - **Set up emergency lights if required.**
- Contamination or injury from exposure to hazardous substances.
 - **Stay well clear until scene is deemed safe by fire services.**



Making the site safe

- Risk of electric shock.
 - **Consider carefully the siting of electrical goods, keep out of direct rain.**
 - **Electrical equipment to be maintained and tested by authorised service agent according to national safety requirements.**
- Risk of tripping.
 - **Consider positions of cable runs.**

At the scene

- Risk of injury due to impact from moving vehicles.
 - **Where practicable, always exit and enter vehicles and deal with occupants from the side away from live traffic lane.**
 - **If possible do not work in live traffic lane. If unavoidable, use other team member as look out whilst carrying out work.**
 - **Consider use of two way radios.**



At the scene

- Risk of inhalation of exhaust fumes from stationary emergency service vehicles.
 - **Try not to work in an area that has a high level of exhaust fumes.**
 - **Consider team member rotation.**
 - **Regular breaks away from the scene.**
- Risk of personal injury from airbag and pretensioners.
 - **Do not tamper with undeployed airbag/pretensioners.**
 - **Do not work directly in front of undeployed airbag**
 - **Keep fingers clear of pretensioners.**

At the scene

- Movement of vehicle or load during course of inspection.
 - **Assess stability of vehicle.**
 - **Ensure vehicle handbrake is properly applied and ignition switched off (be aware of preservation of evidence, if unsure check).**



Contamination by oils, fuel, greases etc.

- **Consider use of protective goggles and disposable gloves or hand wipes.**



At the scene

- Contamination from burnt out vehicles.
 - **Use of protective clothing.**
- Loose debris or fluid causing damage to eyes.
 - **Eye protection to be worn.**
 - **Suitable first aid equipment to be provided.**
- Flammable liquids.
 - **No smoking at crash scenes.**
 - **Be aware of others smoking i.e. bystanders or others involved in the collision.**



At the scene

- Contamination by hydrofluoric acid present in fire damaged vehicles.
 - **Emergency contact advice to be available.**
 - **Protective gloves to be worn during inspections of fire damaged vehicles.**
 - **Prompt medical attention must be sought if contamination is known or suspected.**
- Contact with broken glass or jagged metal edges.
 - **Protective gloves to be worn.**



Examining the scene

- Exposure to weather conditions for long periods.
 - **Provide good standard of weather protective garments.**
 - **Take regular breaks in warm vehicle if exposure prolonged.**
 - **Take regular breaks from direct sunshine.**
- Risk of hearing damage from noise of on-scene equipment
 - **Consider use ear defenders whilst noisy equipment is in operation.**



Examining the scene

- Risk of HIV, hepatitis or other communicable disease from contact with body fluids.
 - *Use of protective gloves.*
 - *Inoculations to be maintained.*
- Personal safety whilst on scene
 - *If at any time any team member feels unsafe or threatened then the team must leave the scene immediately.*
 - *If any team member feels uncomfortable about any sights or sounds they being exposed to, they must remove themselves from the scene by returning to the vehicle.*

Post accident

- Distress encountered from sights, sounds experienced whilst on scene or at any time afterwards
 - *If any team member feels uncomfortable about any sights or sounds they being exposed to from attending a crash scene, they must make their feelings known.*
- High stress levels from attendance at collisions involving death and serious injury.
 - *Routine debriefing and availability of stress counselling after traumatic incidents.*



Scene/site examination & recording visual evidence about the crash scene

The In-depth Investigation Process

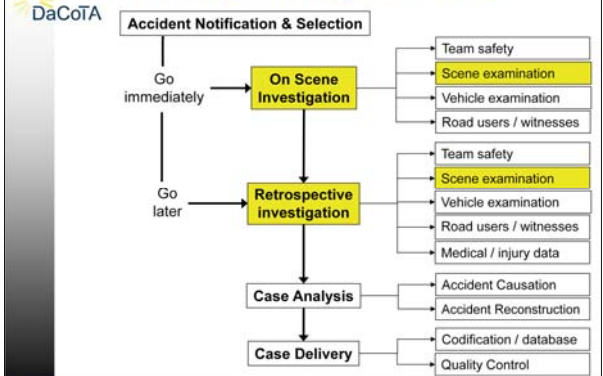

DaCoTA Procedure at crash scene

tasks of a crash investigation team:

- obtain an overview
- gather basic information of every involved party
- safeguard and record volatile data (marks on roads and vehicles)
- make a sketch

This picture shows all the actions that have to be carried out at the crash scene. This presentation focuses on the search for evidence on the road.

73

DaCoTA Basics

- Find out the actions of all involved parties by asking the police, the involved parties and witnesses.
- Collect the essential non permanent traces/evidence and put them into report and hand sketch.
- Create a scaled sketch of the crash scene including traces, points of rest of the vehicles and persons

74

DaCoTA

Documentation of the scene

75

DaCoTA Documentation on-scene

Very fast changeable traces:

- End positions of vehicles (e.g., wheel marks)
- End positions of injured pedestrians, cyclists, PTW riders and/or vehicle occupants
- Position of objects/vehicle parts (e.g. properties of the pedestrian, glass splinters, fallen-off debris)
- Easily removable traces like wipe-, slide- or blood traces (use magnets / sticker arrows)
- Movable / temporary sight restrictions
- Damages to the environment
- Measurement photos

When the team goes on-scene, the most important information to collect and document is information that can disappear or be changed very quickly.

76



- Environment of the crash location
 - Elements of the cross-section (lanes, markings, ...)
 - Radii of bends
 - Presence and type of facilities for VRU
 - Characteristics of the roadside (type and width of hard shoulder, semi-hard shoulder obstacle-free zone, (rigid) obstacles, slopes)
 - Land use
- Permanent sight restrictions
- Traffic signs and signals (at location & approach)
- Trajectories of vehicles/participants (approach)

Other, more permanent aspects of the crash location can also be documented on a second visit.

Recognizing and recording traces on the scene



Traces on the roadway surface

- Tire marks
 - Driving marks
 - Brake / brake lock marks
 - Discontinuity of tire marks
 - Drift marks
 - Skid marks
- Scratch marks
- Stroke marks
- Drag marks
- Material marks
- Biological marks
- Situational marks



Tire marks: Driving marks

Origin: From the rolling wheel which runs through a puddle or makes an impression on loose soil.

Conclusion: Shows the way of travel before or after a collision. For some crash types, driving marks on a grass strip may indicate the cause of the crash.



Tire marks: Braking marks / brake lock marks (1/2)

Origin: A braking wheel can only transmit a brake force on the ground if there is slip between the wheel and the road surface. If a wheel locks when braking it skids with 100% slip. A wheel with significant slip values usually leaves visible marks on the road surface. These marks are:

- Tire abrasion on the road surface due to dissolved tire rubber from the friction
- On sand, gravel or grass: displacement or churning of the subsurface

Conclusion: Brake marks not only show the way of travel of a vehicle but also give information on deceleration and speeds.



Tire marks: Braking marks / brake lock marks (2/2)

Wheels that lock up when braking often show traces on the tire tread in form of a flat spot. This occurs especially on long braking distances. These flat spots indicate which wheel was responsible for the brake lock marks.



When braking, the tire traces of a vehicle's front wheels are usually much stronger than the traces of the rear wheels. Due to a displacement of weight to the front axle when braking and due to less brake power distribution to the rear axle there are often no traces found of the rear wheels

Tire marks: Unsteadiness of tire marks (1/5)

Tire marks may be unsteady.

In this case there has been an external interference in the vehicles movement (impact with another vehicle or a pedestrian) whereby the driving dynamics of the vehicle were changed.

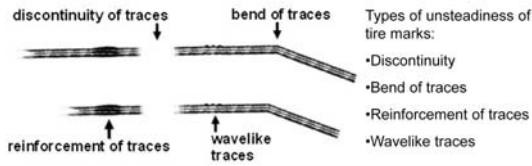

- Types of unsteadiness of tire marks:
- Discontinuity
 - Bend of traces
 - Reinforcement of traces
 - Wavelike traces

Tire marks: Unsteadiness of tire marks (2/5)

DISCONTINUITY OF TRACES

Origin: In some cases a discontinuity of the tire traces as a result of the impact may be seen. Due to the collision there may be a temporary load relief of a wheel.

Conclusion: The discontinuity of tire traces may show the position in which the braking wheel was at the moment of the collision. That way the collision point may be fairly narrowed down.



Tire marks: Unsteadiness of tire marks (3/5)

BEND OF TRACES

Origin: Bend tire traces occur when the braking vehicle collides with another vehicle or object. In that case the movement of the braking vehicle is changed to another direction due to the collision.

Conclusion: The bend of the tire traces shows the position in which the braking wheel was at the moment of the collision. That way the collision point may be fairly narrowed down.



Tire marks: Unsteadiness of tire marks (4/5)

REINFORCEMENT OF TRACES

Origin: Here usually a small external force was applied on the braking vehicle e.g. by a pedestrian or bicycle. This force was not strong enough to alter the direction of travel of the vehicle or bring the braking wheels to swing. However, the force was strong enough to show as a slight reinforcement of the tire trace.

Conclusion: The reinforcement of tire traces may show the position in which the braking wheel was at the moment of the collision. That way the collision point may be fairly narrowed down.



Note: Reinforcement of tire traces may also occur when the wheel runs over a bump on the road surface changes.

Tire marks: Unsteadiness of tire marks (5/5)

WAVELIKE TRACES

Origin: In this case there was also an external force applied on the braking vehicle (e.g. collision with a pedestrian). This force however was not strong enough to alter the direction of travel of the vehicle and the tire traces may have a wavelike character. This is especially the case if the force was applied directly to one of the wheels. The wheel may swing for a short distance and then stabilize again.

Conclusion: The beginning of wavelike tire traces indicate the position in which the braking wheel was at the moment of the collision. That way the collision point may be fairly narrowed down.

Note: Wavelike traces may also occur when the wheel runs over a bump on the road or when there is a defect on the wheel suspension



Tire marks: Drift marks

Origin: Drift marks occur when a vehicle moves with a yaw angle to the direction of travel. The vehicle is oversteering or understeering.

Conclusion: Drift marks not only show the way of travel of a vehicle but also give information on deceleration.



Tire marks: Skid marks

Origin: Skid marks occur when a vehicle skids uncontrolled. The marks may cross each other when the vehicle rotates around its vertical axis. This may happen when the vehicle has had an excentric collision or a driver lost control of a vehicle due to a driving error.

Conclusion: Skid marks are often found between the collision point and the point of rest of a vehicle and give information on deceleration speeds and movements.



Scratch marks

Origin: Scratch marks occur when moving hard objects are pressed on the roadway surface. These marks are usually caused by vehicle parts.

Conclusion: Scratch marks are found between the collision point and the point of rest of a vehicle.



Stroke marks

Origin: Unlike scratch marks stroke marks occur when hard objects are pressed locally on the roadway surface.

Conclusion: Stroke marks are found close to the collision point.



Drag marks

Origin: Drag marks occur when a relatively soft object is dragged over the road and leaves abrasion marks. Materials and objects that leave drag marks are clothing, plastic, painted vehicle body parts, helmets, bags and also skin, or hair.

Conclusion: Drag marks indicate the direction of post crash movement.



Material marks

Origin: Material marks are traces of material that don't adhere to the roadway surface. This could be shattered glass, dirt from inside the fender, leaking vehicle fluids like oil, water, brake-fluid etc.

Conclusion: Drag marks may indicate the collision point. Furthermore, different debris patterns may indicate the collision speed.

Note: Material marks should be marked as soon as possible because they can be altered easily by wind, rain or rescue measures.



Biological marks

Origin: Biological marks are traces of organic material (from humans, animals or plants). In the case of road accidents this includes blood, hair, skin, body or bone parts, parts of plants.

Conclusion: Biological marks may indicate the course of the accident, the throwing distance or the impact point of involved persons or the point of rest of persons, animals or plants. Furthermore, blood splatters may show a direction of movement.



Situation marks

Origin: Situation marks are the points of rest of involved vehicles or persons. These include the position of torn off vehicle parts, thrown off load as well as torn off body parts or carried objects like bags, umbrellas et cetera.

Conclusion: Situation marks may indicate the course of the accident and speeds of vehicles. Furthermore, in combination with other traces/marks situation marks may indicate the point of collision or direction of motion of pedestrians.



Traces on/in vehicles as well as on persons and clothing

- Damage marks
- Material marks
- Smear/wipe marks
- Impression marks
- Adhesion marks
- Biological marks
- Injuries

Damage marks

Origin: Damage marks occur when a vehicle collides with at least one collision partner (vehicle, pedestrian, object, building). These marks are deformations, torn off parts, scratches, bends, etc. on vehicles or objects.

Conclusion: Damage marks may indicate direction of travel and the collision constellation of collision partners. Furthermore, the extent of damages gives information on impact speeds and energies.



Impression marks

Origin: Impression marks are a transfer of a surface pattern to another surface, e.g. tire marks on skin. This also includes a print of a pattern on a dusty surface.

Conclusion: Impression marks indicate a place of contact.



Adhesion marks

Origin: If two objects touch one object may leave material on the surface of the other object. These marks are called adhesion marks

Conclusion: Adhesion marks indicate a direction of movement and a point of contact.



Marking of traces: materials

Crash specific marks, traces and other reconstruction evidence can be marked with chalk for better recognition on photos, and to secure non-permanent information like POR of vehicles (may be towed away) or other traces that could be carried away by rain, wind, rescue measures etc.



Marking of traces: symbols

Marking of traces

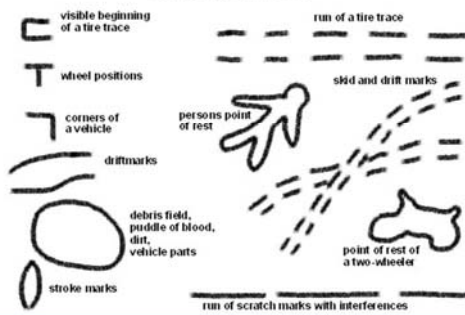

Marking of traces: example 1

The following example shows chalk marking of a break lock tire trace and the point of rest of a vehicle. It also shows that the vehicle has two axles and that the front wheels had no steering angle.

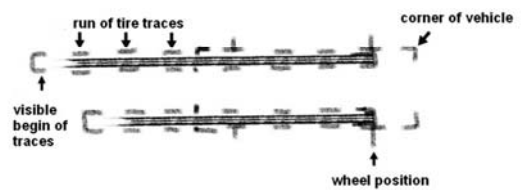

Marking of traces: example 2

Examples of how unsteadiness of tire traces can be marked:

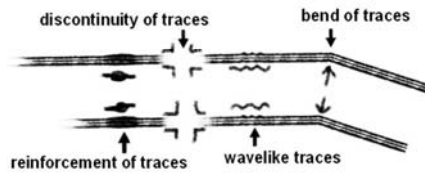

Marking the crash scene

If all traces on the roadway are marked, you get a very good visible image of tire marks and crash evidence:



Taking pictures and sanitising them (on-scene or retrospectively)

First pictures

- Scene atmosphere
- Overall view of the scene
- Weather/lighting conditions
- Involved vehicles
- Tracks / marks / debris
- Visibility mask
- Approaches



DaCoTA **Visibility mask: examples**

Parked vehicles



Wall



Vegetation



Difficulty
Not stationary mask

109

DaCoTA **Pictures related to the approaches**

Approach for pedestrian



Approach for vehicle A

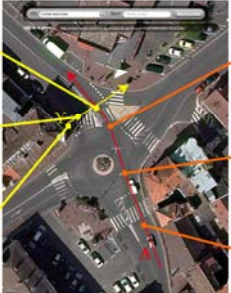



110

DaCoTA **Ethical and legal aspects**

Make sure that there are no identification clues on the pictures for ethical and legal aspects:

- Image rights
- Anonymous data



In practical terms:

- Delete any clue that could give the possibility to identify someone directly or indirectly

111

DaCoTA **Ethical and legal aspects: example 1**

Pre-collision pictures

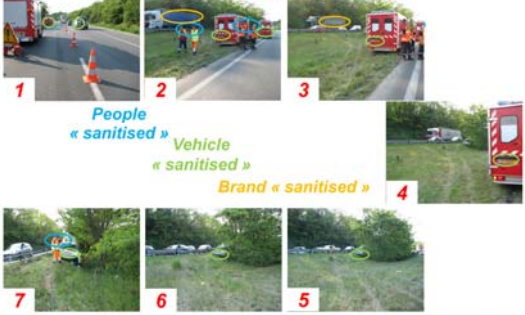

1 **2** **3** **4** **5** **6** **7**

People « sanitised »
Vehicle « sanitised »
Brand « sanitised »

112

DaCoTA Ethical and legal aspects: example 2



- People « sanitized »
- Vehicle « sanitized »
- Brand « sanitized »

DaCoTA Ethical and legal aspects: tools 1

- Software
 - Graphical editing programs: paintshop, photoshop...
 - Squares hiding persons, vehicle plates...
 - Blur software tools
 - Painting tools

!! Merge all the layout!!!



DaCoTA Ethical and legal aspects: tools 2

- A number plate mask



DaCoTA Night pictures

- Take all relevant pictures of the accident scene in the same (bad) lighting conditions



- The severest test in accident-investigation photography!!!!

Night pictures: preparation

- Do not forget to fix the scene accident first
- Tools
 1. The camera should be on a tripod or other steady support
 2. A flashlight is essential



117

Taking night pictures: a guide

1. Open the lens to its maximum aperture to let in as much light as possible
2. Have an assistant shine a flashlight on objects to be photographed
3. Use a wire or sport finder if your camera has one
4. Increase the picture sensitivity (ISO)

118

Night pictures: end result

- Try to obtain a complete 'picture' of what a driver or a pedestrian could have seen at night in the available light conditions
 - Difficult task
 - Use available light at different pre-collision positions

Taking measurements
(on-scene or retrospectively)

119

120

Methods of taking measurements

- Rectangular coordinate system
- Triangulation (with/without fixed reference points)
- Path coordinate system
- Photogrammetry
- Total station, differential gps, ...



Rectangular coordinate system (1/3)

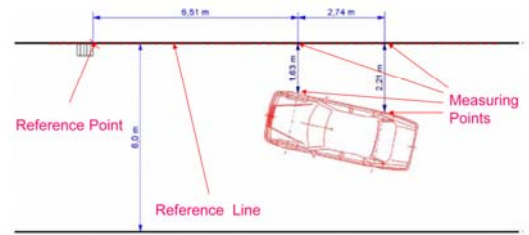

Rectangular coordinate system (2/3)

Premises:

- One or two persons available
- Straight and simple (cross-)road layout is present

Steps:

- Define reference point
- Define reference line (x-axis)
- Mark and number all measurement points on the road
- For long distances (> 3m) use measurement wheel
- For short distances (\leq 3m) use measurement tape

Rectangular coordinate system (3/3)

Pro:

- Very quick and simple method for measuring

Cons:

- Only road layout where reference line is easy to establish

Error sources:

- y-measurement is not perpendicular to x-measurement
- Measuring points are not clearly identified
- No reset of the measurement wheel
- Wheel is not driven in a straight line

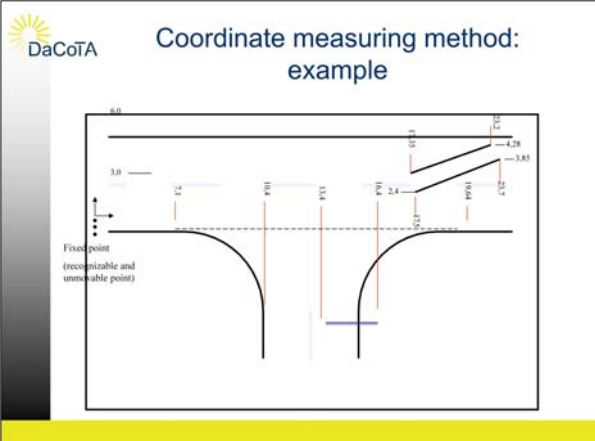

125

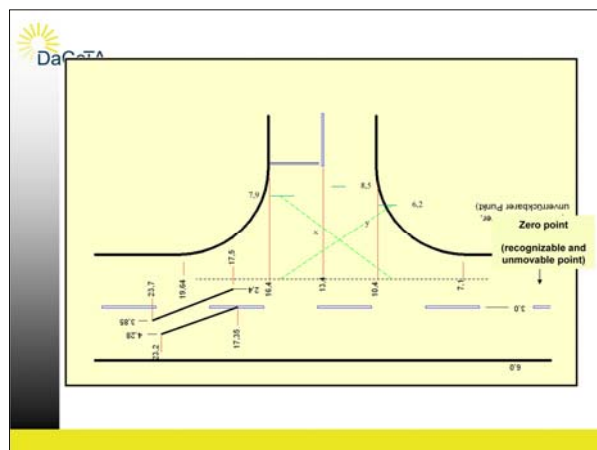

126

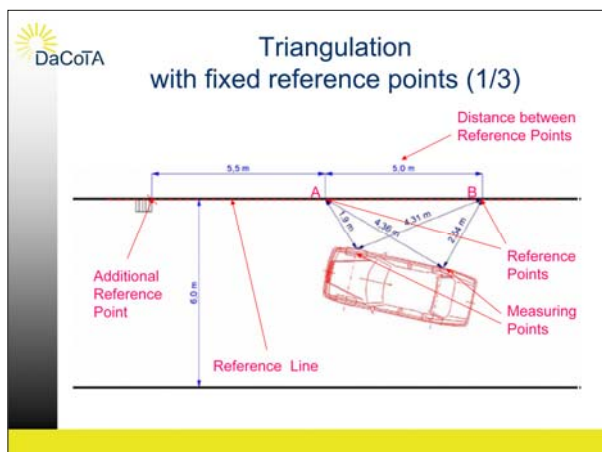

127

DaCoTA

Triangulation with fixed reference points (2/3)

Premises:

- Two persons available
- Complex measurement on straight road layout

Steps:

- Define reference points (and reference line)
- Measure distance between reference points
- Mark and number all measurement points on the road
- Use measurement tape for long and short distances

128

Triangulation with fixed reference points (3/3)

Pro:

- Very accurate method for measuring

Cons:

- Takes more time than other methods
- Two persons required for measuring

Failure Sources:

- Measuring points are not clearly identified
- Distance between reference points is not measured
- Tape is not pulled straight

Triangulation in a curve: with moved reference points

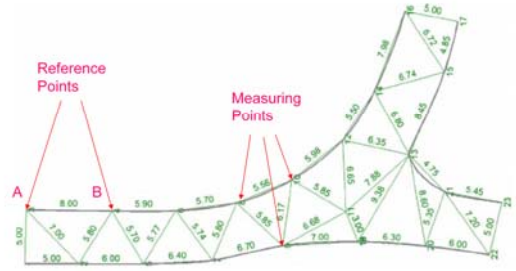

Triangulation in a curve: example (1/6)



Mark with chalk



DaCoTA Triangulation in a curve: example (3/6)

Curve

From	To	Distance
0	1	10,1
1	2	6,7
2	3	9,9
3	4	6,8
4	5	9,5
5	6	7,2
6	7	9,1
7	8	7,6
8	9	8,7
9	10	8,0

DaCoTA Triangulation in a curve: example (4/6)

Photographs on obstructed view

DaCoTA-training: Taking road measurements

DaCoTA Triangulation in a curve: example (5/6)

Measurement protocol

DaCoTA Triangulation in a curve: example (6/6)

Document measurement results (on-scene or retrospectively)

Examples (1/4)

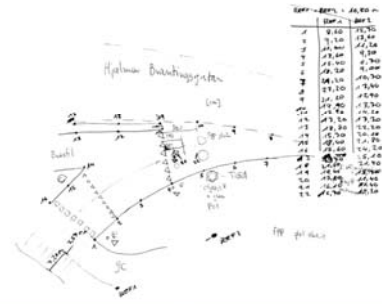

Examples (2/4)

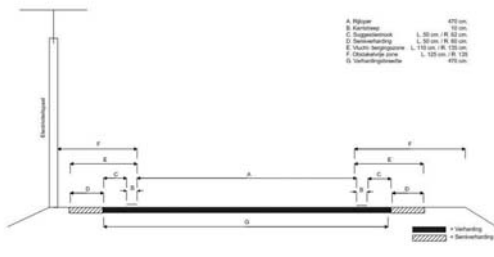

Examples (3/4)



Examples (4/4)

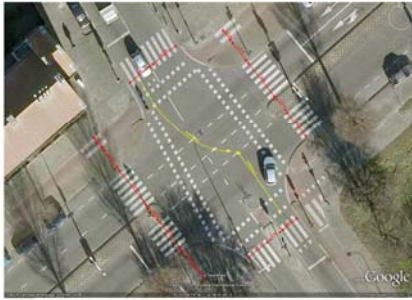

Draw a scene plan or sketch
(on-scene or retrospectively)

Drawing a sketch

- Draw in the north direction
- Choose appropriate scale (1:100, 1:200, 1:400)
- Draw in the scale
- Start drawing with the reference points / line
- Draw in all measured points by using a ruler and / or a compass
- Connect points by using a ruler or burmester curve set
- Draw in vehicle(s) and/or VRU end positions
- Add environmental information
- Add labeling for all relevant lines, curves and dots

Example of a sketch

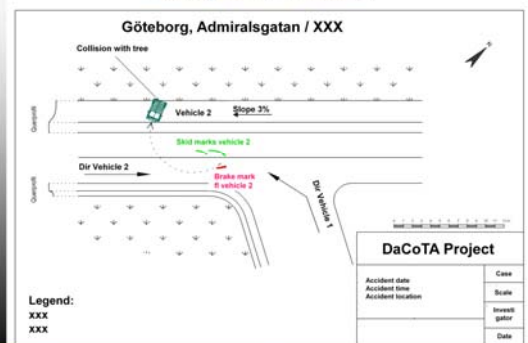

Vehicle Examination

DaCoTA Training week
12.-16. of March
IDIADA, Santa Oliva, Spain

Michael Jansch, MUI

 Project co-financed by the European Commission, Directorate-General for Mobility and Transport

145

To check with Julian
The idea is to have the same process for all and to
locate the module in the data collection process

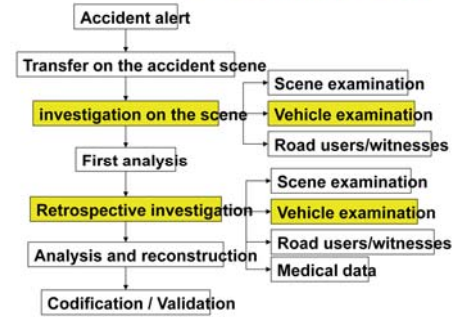

146

Types of vehicles

ELEMENTS in the Database – Accident participants

Vehicles with occupants

- Cars
- Trucks
- Buses

Vulnerable road users

- Pedestrians
- Bicycles
- Powered Two wheelers

147

Methodology of vehicle examination (extract)

- Aim: collect data that describes the vehicle specification, condition, damages, equipment.
- Preferably done on scene, as transient traces may still be visible
- Ask permission to access the vehicle from owner, Police
- Work along data collection forms to collect all information in a structured way
- Distinguish between damages related to the accident and post crash damages from rescue services or from towing the vehicle

148

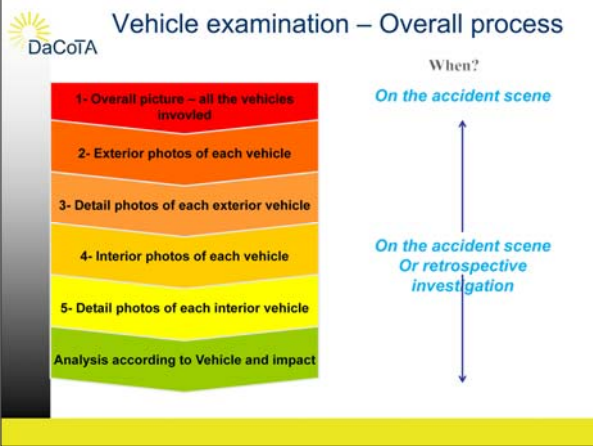

- DaCoTA Vehicle examination – Overall picture**
- What are overall pictures?
 - Pictures on which you understand where the vehicles involved in the accident were at the end.
 - Why?
 - To fix the rest positions from each other
 - To « understand » the collision phase
 - To « understand » the post-collision phase
 - To replace the vehicles in the accident environment
 - Where?
 - At the accident scene
 - How?
 - Both vehicles on the same picture
 - Vehicle picture from the other vehicle point of view
 - Overall picture of each vehicle



- DaCoTA Vehicle examination – Exterior photos**
- What are exterior pictures?
 - Large overview pictures of the vehicle involved in the accident
 - Why?
 - To give the possibility to keep an idea of where the damages were
 - What is the overall state of the vehicle?
 - Where?
 - At the accident scene
 - At the recovery garage
 - How?
 - Take eight photos around the car

In case of removing car roof, take 8 photos without and with the roof

DaCoTA Vehicle examination – Exterior photos

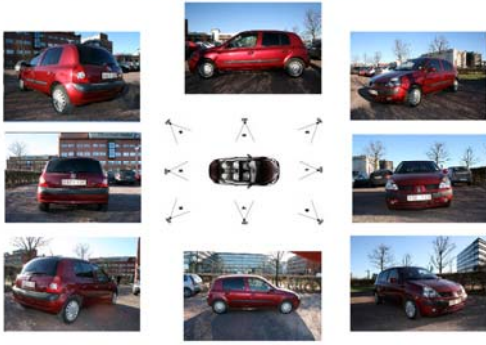

DaCoTA Vehicle examination – Detail Exterior photos

- What are detail exterior pictures?
 - Close up shots of parts of the vehicle involved in the accident
- Why?
 - To gather and use information about the crash
 - To help code the information into the database
 - To understand and define the crash and collision (with another vehicle or obstacle) parameters
 - To strengthen the vehicle measurements (for instance, the EES)
 - To keep visual evidences that are not useful for the database but that could be used for innovative studies
- Where?
 - At the accident scene
 - At the recovery garage

DaCoTA Vehicle examination – Detail Exterior photos

- How?
 1. Use a flash for your camera or a tripod if the lighting conditions are bad (dark, cloudy, night, etc)
 2. Choose the camera autofocus mode or a focal length higher than 35 mm for a digital camera and 50 mm for an older cameras
 3. Take at least two photos of each detail:
 - The detail and its environment
 - Focus on the detail

A ruler or coin can be placed next to objects photographed close up to demonstrate the object's size.

DaCoTA Vehicle examination – Detail Exterior photos

- How?
 4. Take, at least, detailed pictures of the engine compartment and all relevant details like deformations, impacts, tyres etc
 5. Detail photos depend also on the kind of impact (frontal, lateral...)

Vehicle examination – Detail Exterior photos



Several detail pictures with a ruler to scale the impact

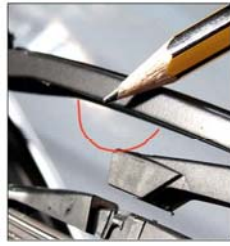

Pedestrian impact - Hair on the windscreen wiper (in red)

157

Vehicle examination – Interior photos

- What are interior pictures?
 - Large overview pictures of the inside of the vehicle
- Why?
 - To give the possibility to get an idea of where the damages inside the vehicle were
 - What could have injured the road user?
 - What was the load inside the vehicle?
 - What was the overall state of the passive safety systems?
 - What was the leg space?
- Where?
 - At the accident scene
 - At the recovery garage

158

Vehicle examination – Interior photos

- How?
 1. Do not forget your safety equipment and process!
 2. Use a flash for your camera or a tripod if the lighting conditions are bad (dark, cloudy, night, etc)
 3. Choose the camera autofocus mode or a focal length of 35 mm for digital camera and 50 mm for older cameras
 4. Take interior side photos, two photos in the front seat and one in the rear seat for each side.

It is important that the opposing door is closed

159

Vehicle examination – Interior photos



160

DaCoTA Vehicle examination – Interior photos

161

DaCoTA Vehicle examination – Detail Interior photos

- What are detail interior pictures?
 - Close up shots of the interior of the vehicle
- Why?
 - To gather and use information about the crash
 - To help code the information into the database
 - To understand and define the injury mechanism
 - To strengthen the vehicle measurements (seat position, dashboard intrusion,...)
 - To identify the use and the good or bad working of any passive safety systems
 - To keep visual evidence that is not useful for the database but could be used for innovative studies
- Where?
 - At the accident scene
 - At the recovery garage

162

DaCoTA Vehicle examination – Detail Interior photos

- How?
 1. Use a flash for your camera or a tripod if the lighting conditions are bad (dark, cloudy, night, etc)
 2. Choose the camera autofocus mode or a focal length higher than 35 mm for digital camera and 50 mm for older cameras
 3. Go inside the vehicle, if necessary to take interior detail photos.
 4. Take at least two photos of each detail:
 - The detail and its environment
 - Focus on the detail

Each accident and crash is different, it is important to take pictures of relevant information trying to answer the following questions: how the road user has been injured and how the road user has been protected?

163

DaCoTA Vehicle examination – Detail Interior photos

- How?
 5. Take a picture of the dashboard from the driver seat

164

Vehicle examination – Detail Interior photos

- How?
 6. Seatbelt examination: clue to determine the belt wearing



Marks on the seat-belt :
the user wore the seat-belt

Vehicle examination – Detail Interior photos

- How?
 7. Load limiter examination: clue to determine the belt wearing
 - part of the safety-belt and/or the seat and/or the vehicle



Load limiter – piece of iron which stretches out according to the impact forces (on each picture, from the left to the right the load limiter is more and more)

Load limiter - iron cylinder which twists according to the impact force (on the top, the load limiter was not used and on the right, there was an impact)

Vehicle examination – Detail Interior photos

- How?
 8. The safety-belt buckle: clue to determine the belt wearing



Streaks on the buckle

Vehicle examination – Detail Interior photos

- How?
 8. Pre-tensioners examination: clue to determine the belt wearing



On the left picture, the stalk is completely pushed in on the passenger seat and not on the driver seat and on the right picture, the seat-belt hangs



Vehicle examination – Detail Interior photos

- How?

9. Air-bag examination: an indication about the functioning of it and help to understand the injury mechanisms.



Frontal airbags with blood marks on the driver airbag

169



Vehicle examination – Detail Interior photos

- How?

10. Steering column and wheel examination: helps to understand the injury mechanisms.



Steering wheel probably impacted by the head because of a severe impact

170



Vehicle examination – Detail Interior photos

- How?

10. Dashboard examination: helps to understand the injury mechanisms (deformation or biological marks).



Knee marks on the lower part of compartment

171



Vehicle examination – Detail Interior photos

- How?

11. Other detail examination:
 - Vehicle windows
 - Doors
 - Seat and head-rest
 - Child restraint system
 - Load

List of detail photos of interior car is not exhaustive

172

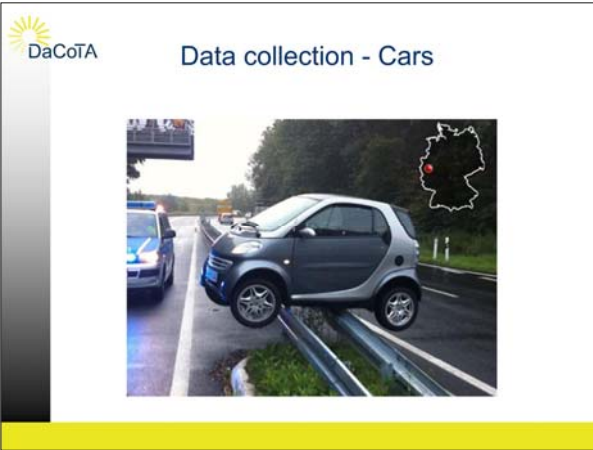

Data collection of the vehicles is not very complicated, however there are quite a lot of variables to collect. Therefore the following presentation will give an overview of the data that needs to be collected for different levels of team-experience but will not go into a lot of detail.

173

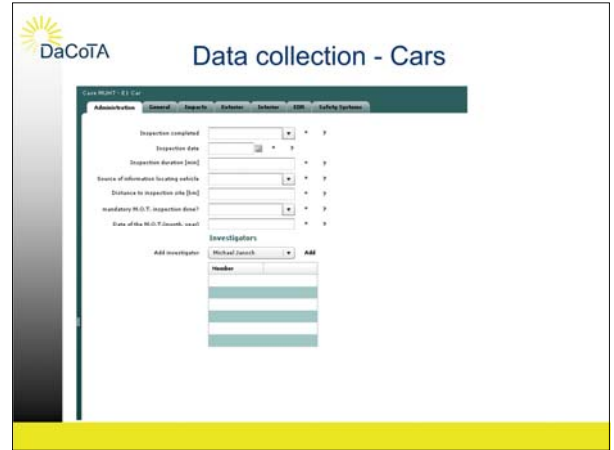

Quick overview of data which needs to be collected

174

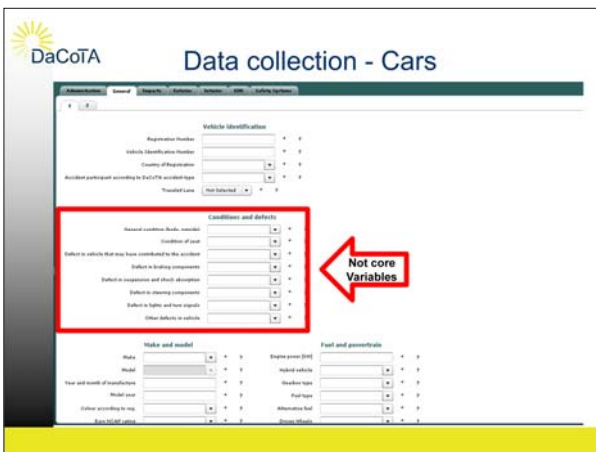

The information on cargo in the vehicle belongs to the core variables because cargo has a significant influence on the dynamical behaviour of the vehicle. This information is used later again for the accident reconstruction .



175

176

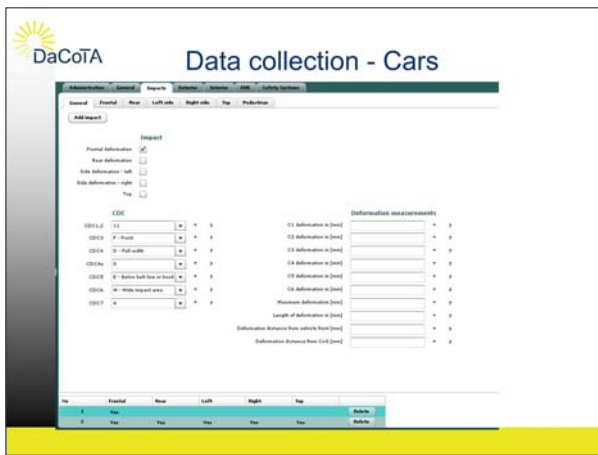

One of the important basics to collect for cars from both experienced and inexperienced teams is the “Collision Deformation classification”. For each impact of the vehicle a CDC is coded. The CDC is a well known coding system for vehicle damages which is internationally used for coding damage and for data analysis.

177

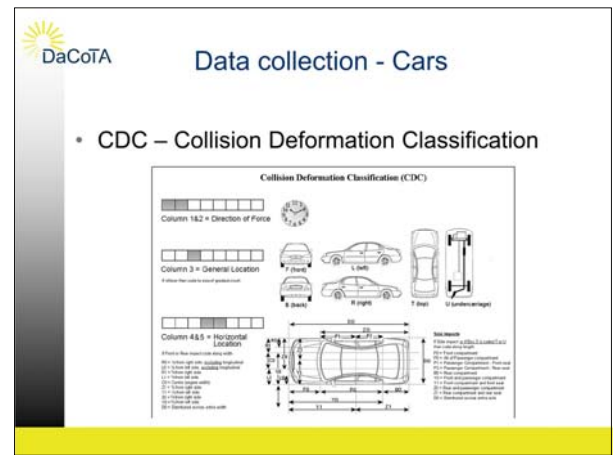

CDC is explained on these two slides

178

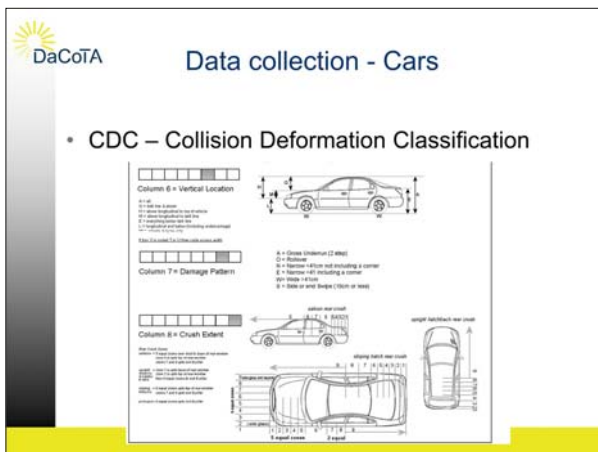

The CDC is explained on these two slides

179

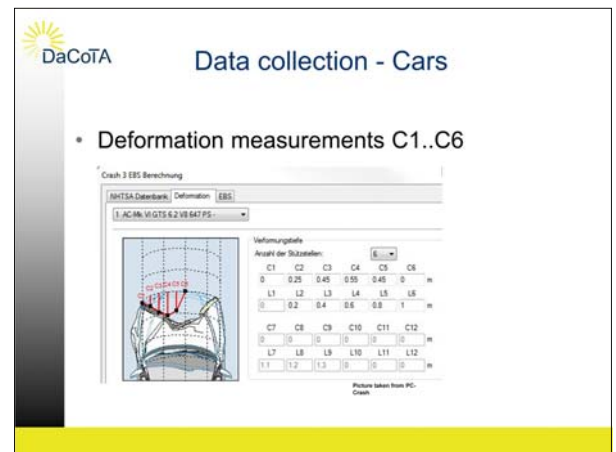

Another way of coding damage information are the variables C1..C6. The damaged area is divided into 6 equal clusters and the deformation depth of each cluster is measured. As opposed to the CDC here the whole area of crush is measured (not only the parts that had contact with the crash opponent). To be able to make an estimation on the energy absorbed by the vehicle during the crash the C1..C6-Deformation is measured at the height of the rigid vehicle structure (sill-height or bumper height)

180

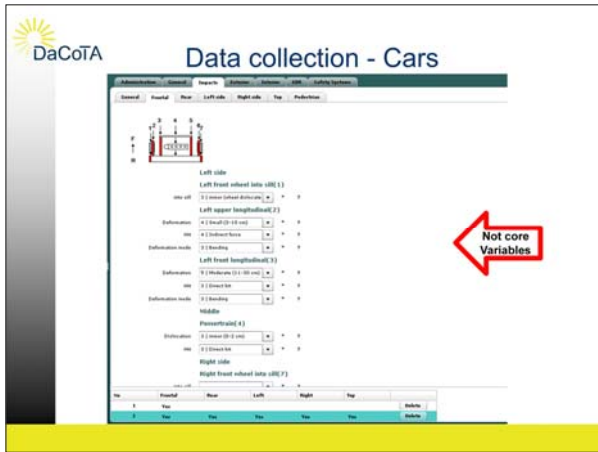

The collection of the deformation information on the cars structural parts such as sills and longitudinal beams from a frontal crash does not belong to the core information which needs to be collected. It should however be noted that this information is also important for experienced teams and a good explanation on how to collect this information is available on the “wiki”.

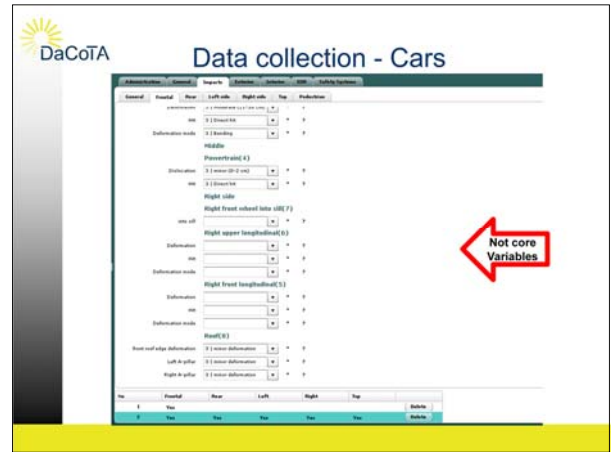

Continuation of the previous slide on collection deformation information on the cars structural parts (only for experienced teams).

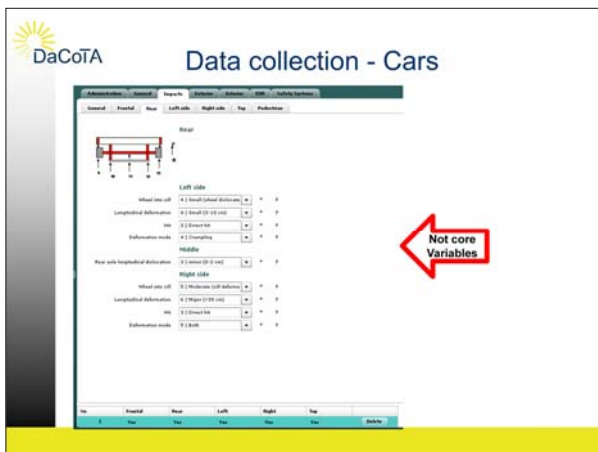

Collection deformation information on the cars structural parts from rear collisions (only for experienced teams).

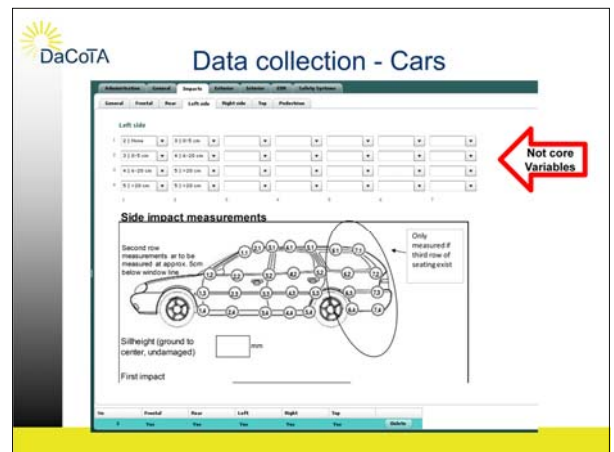

For side collisions a matrix of the deformation depth is collected. This information is only collected by experienced teams as these variables are not part of the core variables.

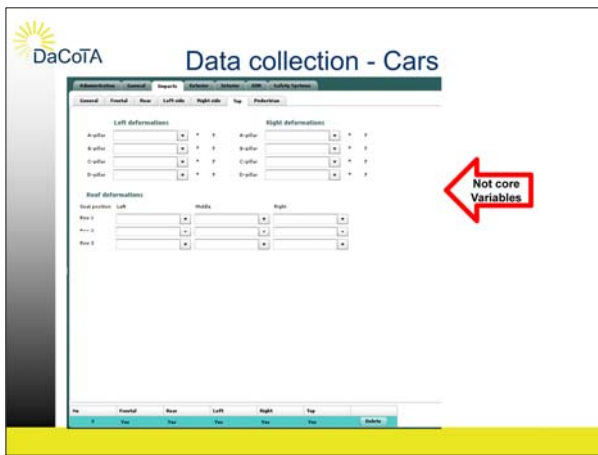

Deformations on the vehicle top are not so common as on other parts. The deformations of the vehicles structural parts on top (A-, B-, C- and D-pillars) on both vehicles sides are measured. Additionally the roof deformation downwards towards the occupants on the different possible seating positions are recorded.

185



Especially for collisions with vulnerable road users the damage on the car is often barely visible and coding systems such as the CDC and C1..C6 are not of much use. Therefore it is important -also for an accident reconstruction- to collect the position of contact marks at the vehicle in combination with detailed pictures of these marks.

186

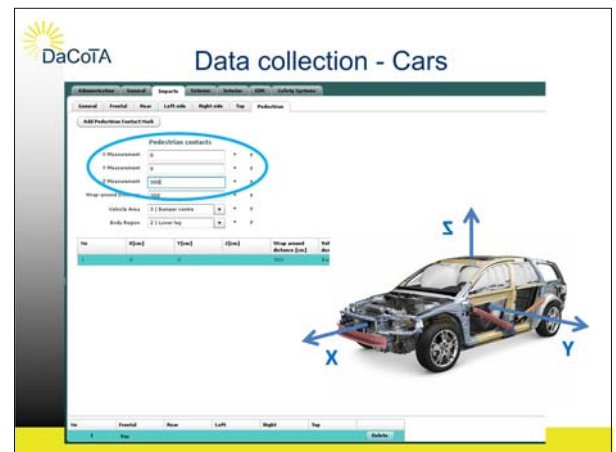
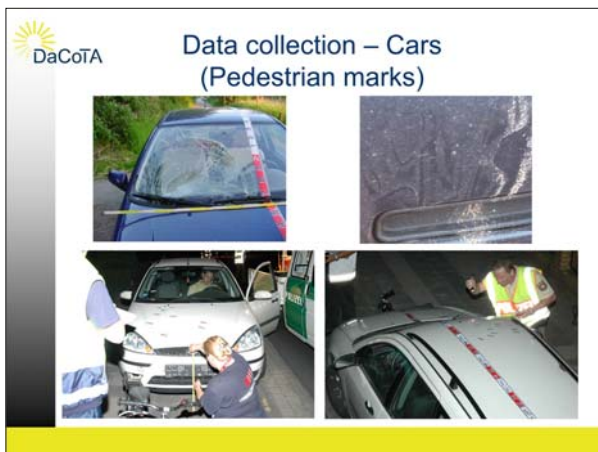

The position of pedestrian contact marks on the car is collected according to the standard system of coordinats.

187

188

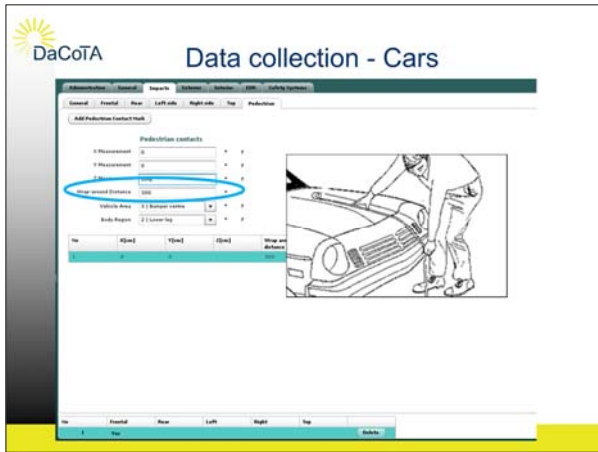

The wrap around distance is measured with an elastic tape measure from a contact point on the vehicle to the ground (as seen on the picture). Depending on the height of the pedestrian with the information on the wrap around distance it is possible to estimate the collision speed of the car by using empiric tables.

189

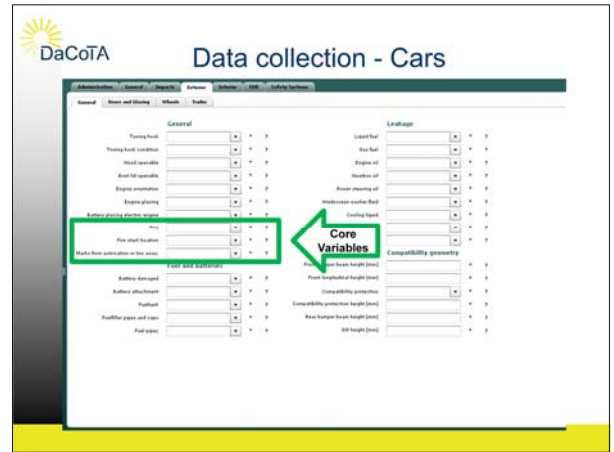

On the general part of the vehicle exterior only the information on fire due to the accident is relevant for new teams.

190

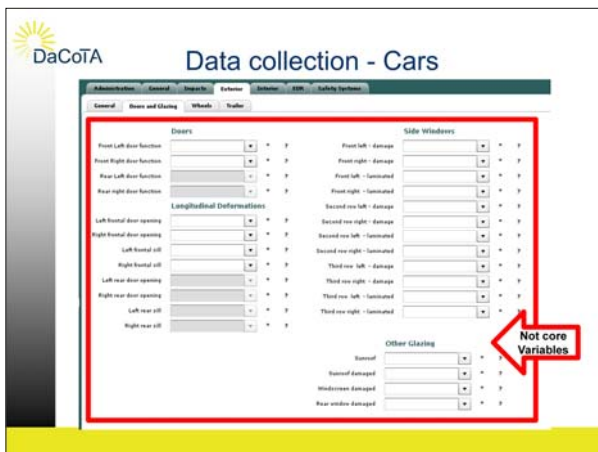

191

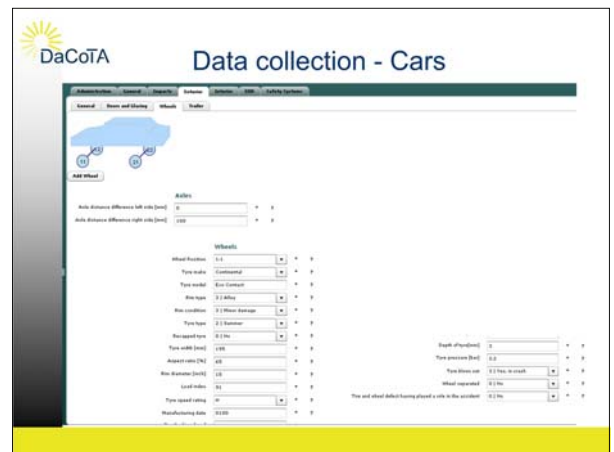

The information on the wheels and tires of a car are important because they have influence on a later part of the case analysis: The accident reconstruction. Wheels are the cars connection to the ground and have significant influence on the dynamical behavior of the vehicle.

192



How to read and decode the information available on the tires side wall is well explained in the DaCoTA – Wiki.

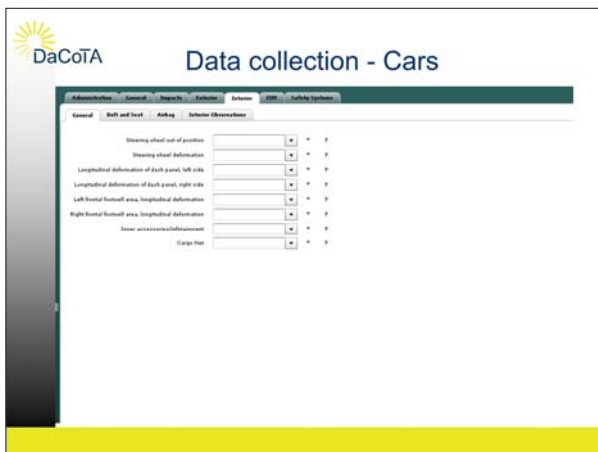
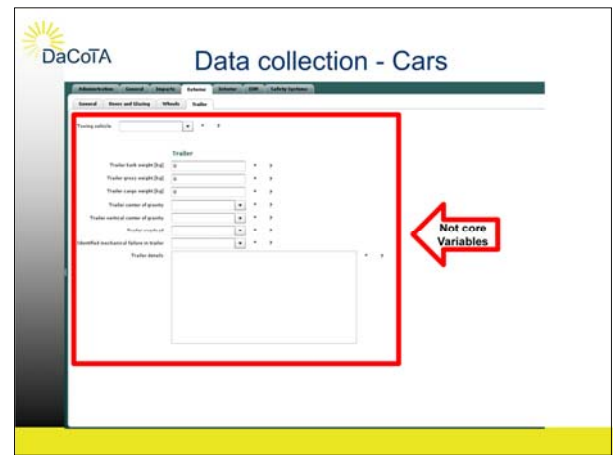

The interior deformation of the vehicle may often be linked to injuries from the occupants.



For each occupant in the vehicle information on the seat is added.

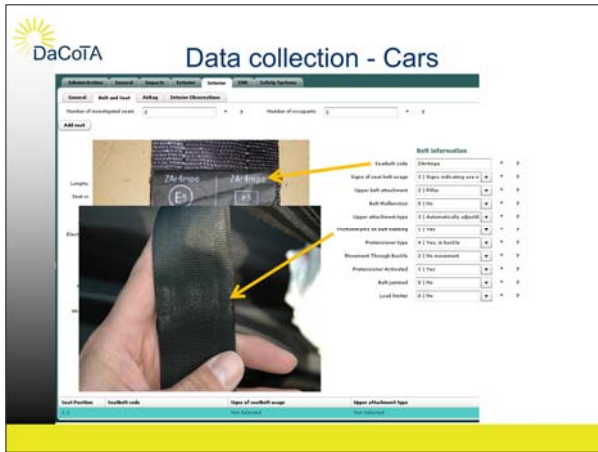

The information on the seat belt of each occupant is collected. Here the „seatbelt code“ delivers important information on belt related passive safety devices such as “pretensioner” and “load limiter”.

197



198

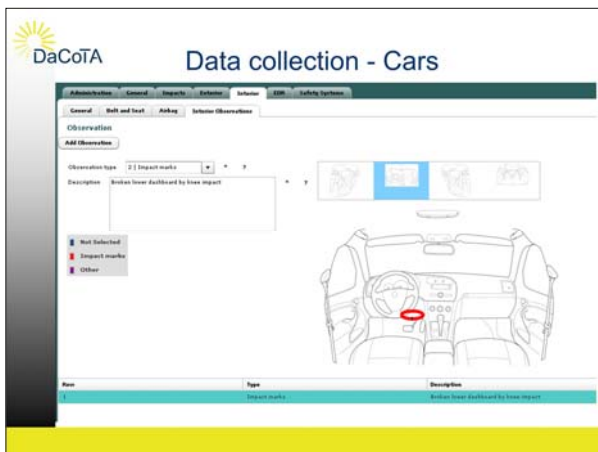

Interior observations may be added by using this graphic tool. For different perspectives of the car interior the position of e.g. impact marks can be drawn on the picture. Together with each mark a description of the mark is saved to the database.

199

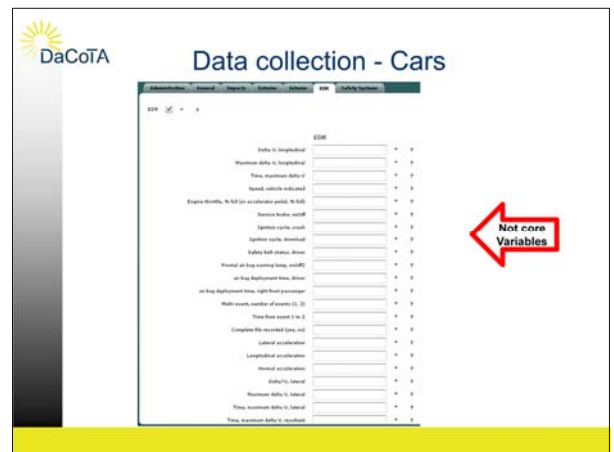

200

DaCoTA Data collection - Cars

The screenshot shows a web-based data collection form for cars. It is divided into several sections:

- Support and Warning Systems:** Includes options for Impairment warning, Air-lock, Lane departure warning, Forward collision warning, Rearward collision warning, Cruise control, Blind spot indicator, GPS, and Active hood.
- Brake and Handling Systems:** Includes Electronic stability control, Traction control system, ABS, Active brake lights, Brake assist, and Automatic emergency brake.
- Visibility:** Includes Xenon lights, Night vision, and Active headlamps.

 Each option is accompanied by a dropdown menu with values like 'Yes, not in use', 'No', 'Yes, unknown if in use', 'Yes, in use', 'No', 'Yes, seen/adapted, will', 'Yes, seen/adapted, will', 'Yes', 'Yes, both high and low', 'No', and 'Yes, not in use'.

201

DaCoTA Data collection - Trucks

The image shows a truck that is completely obscured by a massive, multi-colored pile of bags and boxes, illustrating extreme cargo loading.

202

DaCoTA Data collection - Trucks

- Administration
- General
- Impacts
 - General
 - Pillar
 - Roof
 - Cab
 - Underrun protection
 - Pedestrian
- Exterior
 - General
 - Geometry
 - Doors and glazing
 - Trailer
 - Wheels
 - Cargo and weight
- Interior
 - General
 - Belt and Seat
 - Airbag
 - Interior Observations
- Safety Systems

Database-structure of the data collection for trucks.

DaCoTA Data collection - Trucks

- Administration
- General Variable „Combination type“
- Impacts
 - General
 - Pillar
 - Roof
 - Cab
 - Underrun protection
 - Pedestrian
- Exterior
 - General (only Fire)
 - Geometry
 - Doors and glazing
 - Trailer
 - Wheels
 - Cargo and weight
- Interior
 - General (only Steering wheel deformation)
 - Belt and Seat
 - Airbag
 - Interior Observations
- Safety Systems

Green: Tabs with core variables

The variable groups that include core variables are marked in green.

203

204

DaCoTA Data collection - Trucks

Description
Describe the complete vehicle combination - truck + trailers (if attached). See picture for illustrations.

- Tractor only
- Tractor with semitrailer
- Tractor with semitrailer + centre axle trailer
- Tractor with B-double
- Tractor with 2 semitrailers
- Truck only
- Truck with centre axle trailer
- Truck with drawbar trailer
- Truck with dolly + semitrailer

205

DaCoTA Data collection - Trucks

- Administration
- General
- Impacts
 - General
 - Pillar
 - Roof
 - Cab
 - Underrun protection
 - Pedestrian
- Exterior
 - General (only Fire)
 - Geometry
 - Doors and glazing
 - Trailer
 - Wheels
 - Cargo and weight
- Interior
 - General (only Steering wheel deformation)
 - Belt and Seat
 - Airbag
 - Interior Observations
- Safety Systems

← Visibility from inside the cabin → **Green: Tabs with core variables**

206

DaCoTA Data collection - Trucks

A truck or bus as opposed to cars has a set of very specific mirrors due to the restricted view from inside the drivers cabin:

On the drivers side the mirror 6D is for watching rearward traffic. The mirror 5D is a wide angle mirror for observing the proximity.

On the passengers side the mirrors 4P and 3P have the same objective as the corresponding mirrors on the drivers side.

The mirror 1F is a wide angle mirror for observing the proximity in front of the vehicle

The mirror 2P is a wide angle mirror for observing the proximity on the passengers side of the vehicle (e.g. bicyclists when turning).

207

DaCoTA Vehicle examination session. Busses

VARIABLES: roof deformation and pillar deformation.

- Injury mechanism in rollover accidents: intrusion of the roof and therefore direct contact gives very serious and fatal injuries.
- Two real accident configurations weaken the superstructure, and cause the collapse of this structure when the rollover occurs.
 - Previous frontal or side impacts with a heavy opponent vehicle.
 - Bus sliding velocity on the side structure or

208

Vehicle examination session. Busses
DaCoTA

VARIABLES: seat deformation.

- Injury mechanism in frontal collisions: the seats and their anchorages should tolerate the more typical efforts which appear in real accidents.
- Two seats in the bus are especially exposed in frontal collisions: the driver seat and the tour guide seat. Specific studies are being carried out for these seats.



Vehicle examination session. Busses
DaCoTA

VARIABLES: interior contacts.

- Other important cause of injuries for the bus occupants is the impact against sharp edges (television box,...) or rigid elements (luggage compartment, handle,...), caused by the projection of the occupants.



Michael Jänsch
Project engineer
Jaensch.michael@mh-hannover.de

Accident Research Unit at
Medical University of Hanover
Carl-Neuberg-Str. 1, 30625 Hannover
Tel. +49 511 532 6420



**Vulnerable Road User (VRU)
Data Collection**

DaCoTA Training week
12.-16. of March
IDIADA, Santa Oliva, Spain

Dimitri Margaritis, CERTH/IT

Project co-financed by the European Commission, Directorate-General for Mobility and Transport

1. Vehicle examination and Protective Equipment: Pictures
2. PTW database variables
3. Protective Equipment database variables
4. Bicycle database variables
5. Pedestrian database variables
6. Child Restrain Systems variables

ELEMENTS in the Database – Accident participants

Vehicles with occupants

- Cars
- Trucks
- Buses

Vulnerable road users

- Pedestrians
- Bicycles
- Powered Two wheelers

- Aim: collect data that describes the vehicle specification, condition, damages, equipment.
- Preferably done on scene, as transient traces may still be visible
- Ask permission to access the vehicle from owner, Police
- Work along data collection forms to collect all information in a structured way
- Distinguish between damages related to the accident and post crash damages from rescue services or from towing the vehicle

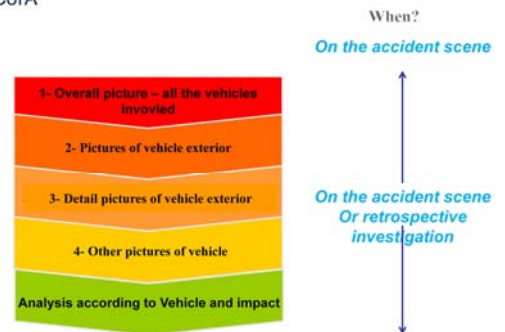

DaCoTA Vehicle examination – Overall pictures

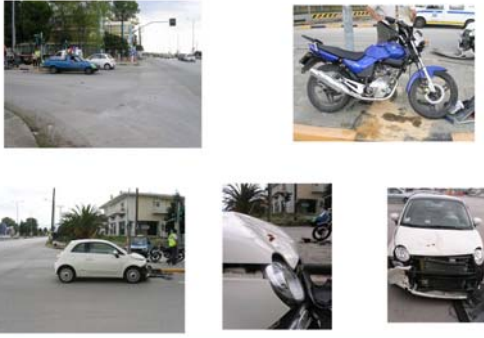

DaCoTA Vehicle examination – Vehicle pictures



Always take care that the PTW is securely standing at the upright position!!!

DaCoTA Vehicle examination – Detail pictures

- What do we want to capture?
 1. Scrape marks (contact with tarmac)
 2. Scrape/rubber/adhesion marks (contact with other vehicle)
 3. Dents/blood (contact with rider)
 4. Vehicle deformation/damage
 5. Other marks (contact with object)

DaCoTA Vehicle examination – Detail pictures

•How?

1. Use the flash of your camera or a tripod if the lighting conditions are bad (dark, cloudy, night, etc)
2. Choose the camera autofocus mode or a focal length higher than 35 mm for digital camera and 50 mm for older cameras
3. Take at least two photos of each detail:
 - The detail and its environment
 - Focus on the detail

A ruler or coin can be placed next to objects photographed close up to demonstrate the object's size.

Vehicle examination – Detail pictures: examples (1)



Vehicle examination – Detail pictures: examples (2)



Vehicle examination – Detail pictures protective equipment

- **How?**
 1. Outdoor light
 2. Avoid reflections on helmet shell
 3. Take pictures around all sides of helmet
 4. Pay more attention to typical areas of contact with ground such as elbow, knee, shoulder, hand, ankle.



Data collection – PTW



Data collection – PTW variables origin

- Reviewed protocols such as MAIDS, OTS, GIDAS, INTACT
- Even though database size limitation, PTW session is covered well enough
- The OECD RS9/TEG/ protocol (variables, values and definitions) has been used in many cases



Aiming at data continuity and comparability with MAIDS

Data collection – PTW variable groups

- Divided into 3 sub groups
 - General
 - Make-Model (12 variables)
 - Mechanical parts (14 variables)
 - Other (42 variables)
 - Wheel (14 variables)
 - Safety Systems
 - PPE (see next slides)
 - Brake and handling system (11 variables)
- Most values are “Yes-No” or Text format

Of course each team collects as much additional information as possible...

Data collection – PTW variables

Data collection – Protective Equipment



- Pay attention to...
 - Size of the PE and whether it is the appropriate one (check with the PE owner if possible).
 - PE information retrieval through paramedics or medical personnel.
 - Prior damages on protective equipment (ask PE owner if possible).
 - Dust, pock marks on helmet not due to an impact during the accident but when left on ground/moved away!



DaCoTA Data collection – Pedestrians

233

DaCoTA Data collection – Cars variables

The position of pedestrian contact marks on the car is collected according to a coordinate system (see Wiki).

234

DaCoTA Data collection – Pedestrian variables

The pedestrian form (road user one) consists of personal details as well as anthropometric and injury information .

235

DaCoTA Data collection – Child restraint systems

236

236

DaCoTA Data collection – Examples

5-point harness T-shield Overhead Shield

237

First picture to the left shows a rearward facing baby seat.
 Second picture to the left illustrates the ISOFIX attachment.
 The first two pictures to the right illustrate the anti pitch device: top tether.
 First picture in the middle is an integrated booster seat.
 Second picture in the middle shows a belt positioning booster cushion.

DaCoTA Data collection – Wrong examples...

238

DaCoTA CRS in accident – Example (1)

Casper Case N° 2030 - VEHICLE 1		
Make and model:		V.M.
CITROEN	XSARA Picasso	2002
Estimated CES:	EDC	Max deform:
SS60	52R VIEW4	750 mm
Impact type:	No children	M.A.S. vehicle
RIGHT SIDE	2	3
Analysed:	Numerical simulation	No pictures
YES	N/A	-20

239

DaCoTA CRS in accident – Example (2)

SEATING POSITION		Age: 8 years	
REAR LEFT		Male	
Type of restraint:	Use	M.A.S.	
Booster cushion TEAM TEX Polo/Uno Et 03 9000	YES	2	
Injuries			
Femur fracture - right side		Clavicle	ACS code
		Structure of the right front seat headrest	8.5.18.00.2

240

CRS in accident – Example (3)

Casper Case CRS (CITROEN XSARA PICASSO – rear left position)

Misuse: the diagonal part of the seatbelt was possibly positioned over the armpit on the internal side of the booster
 Damage to CRS: none

CRS in accident – Example (4)

SEATING POSITION	Age: 23 months	
REAR RIGHT	Female	
Type of restraint	Use	MAIS
FWD FC Harness Mass Class Front E1 G3 301096	YES	1
Injuries		
Injury	Cause	ATIS code
Contusion of the head	CRS interior or window	1.1.04.02.1
Face around (Dent)	Door panel or bump	2.1.06.02.1



CRS in accident – Example (5)

Casper Case CRS (CITROEN XSARA PICASSO – rear right position)

Misuse: the harness height adjustment, lower slot may be not the most appropriate. The effect in side impact could be minor if the harness is sufficiently tighten (looking at the injuries sustained by the child the effect in the present case is not critical only AIS1)
 Damage to CRS: The CRS is deformed (visible on pictures) and the base shows plastic damages on its right side

Data collection – Child Restrain System variables

The child restrain system sub-form is integrated in the Road User form.

DaCoTA

Dimitris Margaritis
 e-mail : dmarg@certh.gr
 tel: +30.2310.498467

Centre for Research and Technology Hellas (CERTH) /
 Hellenic Institute of Transport (HIT)
 6th km, Charilaou - Themi Road
 P.O. Box 60361, 57001 Themi
 Thessaloniki, Greece
 fax: +30.2310.498269
 home page: www.hit.certh.gr

DaCoTA

Collecting Human Behavioral Data from road users involved in a crash

Pierre Van Elslande
 IFSTTAR

Project co-financed by the European Commission, Directorate-General for Mobility and Transport

If verbal data is collected from human, it does not concern human only.

Verbal protocols will also bring a lot of information on the situation, the accident process, the different factors involves, and so on and so for

DaCoTA

Outline

- What is the value of verbal data
- Questions of ethics to consider
- Questions of reliability in witness statements
- Elements of method
- Practical questions and advices
- Discussion

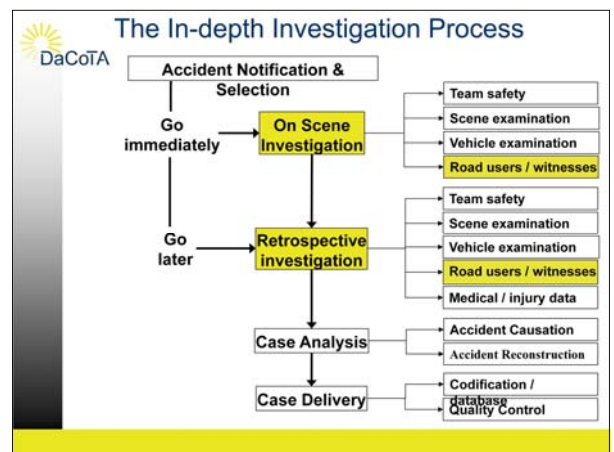

Verbal data from the road users can be collected:

- On the scene (or eventually at the hospital);
- During the days following the crash;
- Both (with the advantage of comparison and complementarity)

Introduction

- In-depth accident studies rely upon a detailed method with the aim to gain the most precise information about:
 - The accident process (clinical approach)
 - The role of the different elements involved and their interactions (system approach)
- Data collection is necessarily interdisciplinary
- To study *human factors* the best way is to appeal to specialists in human factors
- And to get information *from road users* it is useful to be skilled, not only in interview techniques, but also in understanding the human processes at play in driving and in accidents

249

What interest and value?

- Verbal data collected from road users involved in an accident has the purpose to bring information, in the same way as the more objective data collected on the field (road, vehicle, etc.), to promote a more precise description of the facts and their sequences
- This information will allow to bring new elements (to confirm elements) to the analysis of the accident occurrence
- The information given by the different road users' testimonies will also be helpful in order to reconstruct the accident scenario

250

Verbal data is essential to well understand:

- The state of the system (driving context) in which the accident took place
 - Characteristics of the different components involved: road, vehicle, drivers, traffic, weather, etc.
 - The information collected will make it possible to verify/particularize the data directly accessible *ex post facto*
- The course of the events
 - What the road users have seen, understood, done... at the successive steps of the accident process
- The difficulties met and errors committed by the different participants and their perceptions of these difficulties
- The different patterns of elements (factors) having contributed to the emergence of these difficulties

251

How to get human behavioural data?

- The best way to collect verbal protocols relies upon a face to face recorded interview conducted by a skilled investigator (ideally a psychologist if human factors are to be further investigated)
 - Advantage is to allow a good interaction with the interviewee making him more involved and concerned
- When not possible, this interview can be conducted on the phone
 - Allows to keep the flexibility of an interview, even if losing non verbal communication and sometimes getting a lower involvement of the person
- The use of questionnaires is also doable, but with a risk of impoverishment of the information content delivered
 - When confronted with questionnaires, people only **answer** those questions...
- Whatever the method adopted, it is useful to get a first contact, even brief, with the people involved
 - Will improve their willingness to participate to the study later on

252



Questions of ethics to consider

- First approbation by recue services / police
- Consent for interviews
 - Considering the emotional state of the person
- Confidentiality
 - Information got from the road user is his property ...
- Anonymisation of (even not obvious) personal data:
 - Speech (texts) but also images, names of street, dates, etc.
- Storage and protection of the data
 - Depend on each national legislation

253



Questions of reliability in witness statements

- Verbal data is, by definition, subjective
- This subjectivity is important to consider insofar as it can reflect:
 - The true perceptions of the people involved when confronted with the situations
 - By such they are informative of the accident process
 - This "subjectivity" is important to further apprehend
 - But also some biases of expression and mental reconstruction, sometimes deliberate (penal context)
 - These biases must be considered and the information given verified

254



Possible biases to consider in witness statements

- 1) The forgery
 - The road user can deliberately give a version of the facts which releases him from responsibility (while thinking about insurance and so on).
 - It is here that the ability of the investigator to acquire the trust of the person about the confidentiality of the data which is collected can influence.
- 2) The justification
 - The user can try to prove, to others and him/herself, that his/her behaviour obeyed a certain logic, coherent with the capacities of a "good driver", protecting implicitly his/her "self-respect".
 - He can gradually persuade him that what he had envisaged beforehand as a hypothesis is actually true.

255



Possible biases to consider in witness statements

- 3) The rational reconstruction
 - The user can reconstruct the chain of his actions from the elements which he memorized, but he involuntarily fills in the gaps by resorting to his mental representation of his task and his usual ways of functioning.
- 4) The bias of analysis
 - The gap between the declarations and the facts can also be revealing mechanisms of errors which were confronted by the persons. Such inaccuracies are of interest from the point of view of understanding the difficulties really met by the interviewee in situations, his/her perception and interpretation of the process.

256

Testimonies are also reflecting capacities and limits in human perception

- Driving is not a “natural” activity
- Human beings are poorly equipped to drive
 - With very weak sensorial and motor capacity
 - Limits in capacity to detect and to react properly in due time
 - Senses subjects to mistakes and illusions

257

Testimonies also reflect the capacities and limits in human cognition

- Human beings are endowed with highly developed cognitive functions (e.g. comprehension, prevision) and cognitive structures (i.e. knowledge)
- Which allow them to evolve, even in environments which are not fitted to them
- *But only up to a certain degree...*

258

Assessing witnesses statements

- By confronting them with evidence(marks on the road, etc.)
 - Cf. Reconstruction module
 - E.g. Often when drivers say that they “*couldn't brake*”... it means they “*could not stop in time*”
- By relying on the expertise of the investigator
 - Competencies in interview
 - Knowledge about the accident facts
- By comparing with first spontaneous statements (when possible)
- With common sense...

259

Some general principles

- There are various techniques of interviewing, according to the aimed objective (therapeutic, journalistic, survey, etc.).
 - In the frame of In-depth accident studies, the aim is an interview for research
 - Defined as “*An interview between 2 people, conducted and recorded (taking notes biases the speech) by an interviewer whose objective is to favor the production of a linear speech of the interviewee*” (Blanchet et al. 1987)
- The acceptance and the active and effective participation of the person in the interview requires specific skills in the conduct of interview and in the formulation of questions
- The attitude of the interviewer is important
- Appropriate techniques promote better results

260

Attitude

- An appropriate attitude of the interviewer is essential for the quality of the data collected information
 - It is a question of gaining the persons confidence and motivation by showing interest and understanding for what they say
- Benevolent neutrality
 - It is not passivity but a positive commitment based on the interest manifested in the other one and in his speech
 - It is to favor this speech by listening to and by trying to understand the interviewee's point of view (it is not a question of giving to her reason or twists)
- Empathy
 - Capacity to understand the mental states of the other (without sharing them necessarily, sympathy)
 - More generally: capacity to be put oneself in the place of the other one to understand him better

261

Techniques

- Open questions
 - Favours free and spontaneous speech without restriction
 - Allow to get a lot of information
 - To promote at the beginning of the interview
- Closed questions
 - Useful at certain phases of the interview, when precision is needed
 - Not to abuse (or the interview will turn into a yes/no questioning)
 - To promote at the end of the interview
- Alternative questions
 - Allows us to tackle an ambiguous or imprecise fact without using closed questions
 - Also useful when the person doesn't completely understand what she is asked: they become a guide in a spontaneous speech

262

Other useful techniques

In certain circumstances, the interviewer may feel the necessity to use the following specific techniques

- Counter declarations
 - By using the material evidence
 - When the speech is obviously biased
 - Shall be used with tact...
- Deliberate incomprehension
 - To use with moderation: can bring added information, but can also show incompetence (of the interviewer or the interviewee!)
- Silences
 - Silences are most often useful
 - The interviewer must learn to stand them while keeping his manifestation of interest
 - The interviewee must quit the silence by himself (except if you feel that he hasn't anything more to say)

263

Pitfalls to avoid

- Do not use complex questions with technical vocabulary (avoid negations in the questions)
- Do not cut the speech or finish the sentences instead of the interviewee
- Do not precipitate your questions (take the time to think)
- Avoid preconceived ideas (the purpose of the interview is to get information, not to prove an *a priori*)
- Avoid questions which suggest the answer
 - E.g. "You wore your seat belt I suppose?"
- Check if the answer answers the question!

264

Specificity of the accident context

- The act of interviewing road users involved in a crash is a particular task due to the practical conditions, the legal context and the emotions evolved
- Necessity to adapt the interview method accordingly
 - interviewers must take into account the diverse reactions of the person involved in these particular conditions and adapt to it
 - to the objective to collect the best information necessary for the understanding of the accident
 - in respect for the persons and the ethical rules

265

Necessity to adapt

- According to the particular situation, the classical technique of "semi-directive" interview must, be revised either:
 - "Downward", to leave to the person the possibility of expressing themselves freely on a subject which affects her/him, even if it does not interest directly the analysis of the accident (e.g. when the person is manifesting a very strong emotion)
 - "Upward", even if it means pushing the person in a more directive way, when this person is obviously insincere or resistant, (e.g. when contradictory with evidences)

266

The moment of the interview

- Better conduct the interview as soon as possible, considering the *availability* of the people involved
 - so that he/she delivers the most spontaneous information
 - before mental reconstruction or mediation takes place as a result of discussion with others (relatives, police, etc.)
- An efficient way of proceeding relies upon a data collection procedure in two stages:
 - a first (relatively brief, considering the circumstances) interview
 - "on the scene" of the accident (or in the emergency rooms of the hospital),
 - followed by a complementary data collection within the following days directed by ideas built on the examination of the first data collected by the interdisciplinary team

267

The interview must be prepared

- The interviewer must approach the people involved without any preconceptions to avoid the risk of biasing the interview
- But not having preconceptions does not mean being ignorant
- It is necessary to prepare for the interview by getting acquainted with the material circumstances of the accident.
 - how many vehicles involved, understand the overall configuration of the crash, to know its gravity...
- Important to have observed beforehand the site of the accident for an effective interview and a good understanding of the facts described by the road users
- This preparation must rely on an indispensable dialogue with the other investigators
 - not to result in conclusions but to help to ask appropriate questions

268

A guide of questioning

- Investigators must know well in advance the different topics they have to cover during the interview
- The use of an interview guide is useful during the interview to verify the points which have not been developed yet
- But this guide shall not be followed too strictly
 - a good interview is when the different questions come naturally
- Each accident case is specific
- Considering the variety of possible scenarios, it's better to keep flexibility in the questioning
 - There are no systematically already made "recipes" applicable in any circumstances with the people involved because every accident takes the shape of a particular, unique story
 - An interview requires a certain capacity of adaptation of the interviewer according to his/her interlocutor

269

The introduction of the interview

- An efficient interview needs not only the agreement of the interviewee, but also his support to the project of investigating all the facts of the accident
- The quality of the introduction influences the quality of the following of the interview, so it is wise to take the necessary time:
 - To introduce yourself, do not hesitate to give your name
 - Present the frame and the purpose of the work.
 - Reassure the interviewee by bringing ethical guarantees of discretion and none disclosure of the contents of the interview (independence with regard to investigations of police or justice, anonymity in the use of the results)

270

The "open" phase

(interview on the scene / complementary interview)

- The purpose is to collect the main details of the accident as the road user remembers them spontaneously
 - The interviewee is supposed to know the details and the task of the investigator is to listen to him
- This stage is initialized by an open question "*can you tell me how that took place?*"
 - no closed questions, otherwise there is a risk of drying up the information source
 - No interruption as long as he speaks about the accident
- The interviewer will intervene as little as possible and will use the "mirror" technic, neutral demands of additional information, markers of interest to favour the speech of the interviewee, and open questions

271

The "deepening" phase

(usually complementary interview)

- The second stage consists of an exploration of the initial speech to lead to a deeper understanding
- The purpose is to fill the gaps found in the spontaneous speech and to concentrate on specific details, to investigate the "blanks", the ambiguities and the contradictions
- This stage is more directive, the questioning is therefore more methodical
 - It is better to begin with the progress of the accident: it is what the interviewee naturally expects
 - A good practice is to ask the interviewee for a sketch
- The investigator makes use of what he knows already to gain further knowledge.
 - A good knowledge of the accident facts is helpful

272



The "filling in" phase

(usually complementary interview)

- The purpose is there to get all the information peripheral to the accident occurrence (driver's history and so on) that is required for completing the file
- This stage constitutes a change in the content of the interview, and the interviewee can be surprised by this change. It is good to make a transition, such as:
 - *"now I would like to ask questions which concern you more personally. for example I would like you to tell me about your experience of driving, how long have you driven, on which roads, your annual mileage, all this..."*
- No matter that the order of the themes does not respect that of check list, the important thing is that they are well linked like in a conversation, and that all the themes are approached

273



Do not waste time with false witnesses

- Time on the scene is precious
- Some people like explaining what they haven't seen... beware not to be trapped!
- It is necessary to quickly find the right people (drivers, passengers, witnesses) before they are occupied
 - With the help of the other investigator, rescue and police services

274



Speech adapted to the person

- Interviewees are not specialists in road safety
 - Do not expect them to answer the way you would expect...
 - It is sensible for the investigator to adopt a level of language similar to that of the interviewee and to adapt his speech to the capacity and the personality observed
 - for a better mutual understanding.
 - for motivating the verbal productions of the interviewee by acting on his "self-respect"

275



Manage own sense of guiltiness

- During his approach, the investigator is regularly confronted with a certain sense of guiltiness in front of these persons - often in distress - involved in a traffic accident (*"what am I doing there asking him/her what happened?"*)
 - Sometimes difficult to assume
 - Can impede data collection
- It is essential to remember why we are there and to believe in the reason for collecting such data
 - the centring on his professionalism helps the investigator to overcome the gap

276

In what circumstances would you not try to interview a road user?

- Certain precautions of common sense are of course to be taken for the realization of the interview.
- The first one is to wait for the authorization of emergency services
- In the appreciation of the investigator, the interview will not be realized if the person becomes too aggressive; or if he/she seems too much impaired by alcohol or other drugs. It will be better in these two cases to wait for a moment more convenient to the verbal exchange.
- If it is about a minor, the interview has to be made with the authorization of the parents if they are present or of a responsible adult.

How to deal with differences in responses the same person may give at different stages of the process?

- It can happen that what is said in the second interview partly contradicts what has been said in the first one
 - In that case, consider the first version as the most spontaneous
 - The second integrates more thinking and mental reconstruction
 - The differences between the two don't necessarily reflect a will to lie or to hide the truth
 - The interviewer will try to investigate the reasons of these differences by confronting the interviewee with the potential contradictions

Postal questionnaires

Deniz Atalar
Transport Safety Research Centre
Loughborough University

The In-depth Investigation Process

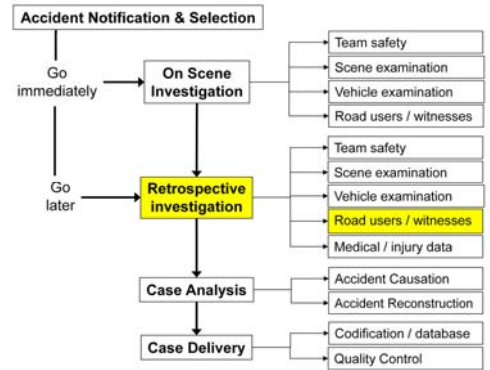

Postal questionnaires are a retrospective investigation of the accident as they are not given out on scene.



Presentation outline

- In depth accident data questionnaires
- DaCoTA questionnaire
- Some considerations
- Future work
- Questions

281



Human behavioural data acquisition

1. On scene interview
2. Follow up interview
3. Telephone interview
4. Questionnaire

This slide demonstrates the different types of data acquisition methods for human behavioural data for in depth traffic accident data acquisition.

282



Human data acquisition

1. On scene interview
2. Follow up interview
3. Telephone interview

4. Questionnaire

283



Benefits of postal questionnaire`s

- Tools to gather information from individuals in a non-invasive manner
- Uniform in nature
- Easy to quantify
- Open ended/ Close ended
- Completed at the respondents own pace
- A good way to get a lot of facts without the need to find and detain someone face to face

284



Postal questionnaire process

- Address of individual involved in the crash is obtained
- Questionnaire is sent out to be completed by the individual at home
- Questionnaire is sent back to the centre

285



Questionnaires used in in-depth studies

- The aim of the questionnaire is usually to mimic the on scene interview information acquired and gather extra information
- Easier to get information on topics that are difficult to talk about in interviews
- Used to compare with previously collected on scene physical information
- Compare with interview/telephone interview data
- Used for statistical analysis

286



Why use questionnaires

- Allows accumulation of routine data from individual such as;
 - Some personal information
 - General driving behaviour information (e.g. kilometres driven in a year)
 - Medical information (e.g. diabetes, any medication taken)
 - On-going health issue's
- A way to gather information for retrospective studies
- Ensures that all questions are asked for information

287



Important things to remember

- The cover letter is very important
- Pre-paid return envelopes for people to send back
- Send a letter or telephone again to ensure people reply
- A response rate over 50% is good!!!!
- Have an open ended area for people to explain the accident
- Some data loss possible

288

DaCoTA questionnaire

- Will be given for the pilot study but will not be a core variable for the five cases
- Each participating country will need to translate this questionnaire to their own language
- Able to do an accident causation analysis using a questionnaire

DaCoTA questionnaire

1. Description of the accident
2. Activities prior to the collision
3. Course of event
4. Collision with the other vehicle
5. The traffic environment
6. The situation before the collision
7. Driver information
8. Cars equipment, Cars airbags and vehicle cargo
9. Passenger descriptions
10. Driver and Passenger injuries
11. Other information

The image shows a detailed view of the DaCoTA questionnaire form. It is divided into several sections with checkboxes and text input fields. Key sections include:

- Course of event:** Asks for a description of the crash, including what happened in the crash (e.g., car skidded, lost control, etc.), what you were doing before the crash, and what you saw just before the crash.
- Collision with other vehicle:** Asks for details about the collision, including the type of collision (e.g., rear-end, side-impact, etc.), the speed of the vehicles, and whether the driver was aware of the other vehicle before the crash.
- What happened in the crash?:** A section for describing the crash event, including the location, time, and weather conditions.
- What you were doing before the crash?:** A section for describing the driver's activities and intentions before the collision.
- What you saw just before the crash?:** A section for describing the driver's observations of the road and other vehicles immediately before the collision.

Some important considerations when using questionnaire data

- Information can be incomplete
- A good way to allow responders to vent about the accident
- In questionnaire's most people show themselves as blameless!
- Focus on cases where people directly blame another road user

OTS study findings

- People involved in road traffic collisions most frequently blame other road users and under-report their own failings
- They are most likely to claim that another road user was rushing or travelling too fast – which may be a general reflection of road traffic collisions as sudden traumatic events and the effect this has on perception
- Those who do not acknowledge their own failings may particularly benefit from active safety systems which compensate for driver error

Future Development

- Complete translation from Swedish to English
- Please feel free to use these questionnaires and add on extra questions if necessary
- Look at ways to compare/combine with the accident data that has been gathered
- Will be a recommendation in the final report

Medical data collection and analysis

Francisco J. Lopez-Valdes^{1,3}, Maria Segui-Gomez^{1,2,3}
Anuncia Ocampo², Alvaro Gomez²

¹European Center for Injury Prevention

²Direccion General de Trafico

³University of Virginia



Project co-financed by the European Commission, Directorate-General for Mobility and Transport

The In-depth Investigation Process

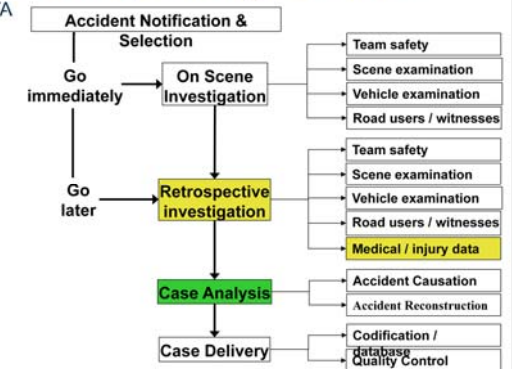

Injury data are collected as part of the retrospective investigation to be carried out after the crash has occurred. The study of injury causation requires the analysis of potential contact points between the vehicle interior/exterior surfaces, knowing the dynamics of the crash and the use of restraint systems and therefore is part of the analysis of the case

Goals

- To show the need of collecting injury data to succeed in the prevention of RT fatalities and injuries.
- To describe different available sources of medical data
- To introduce the AIS and other injury severity scales
- To introduce some biomechanical concepts that can help to understand injury causation

The goals of this session are:

+ Injury and medical information are a KEY component of any information system which has the goal of preventing road traffic fatalities and injuries.

+ the different means of getting access to injury data. And some of the implications of using one source or another.

+ to become familiar with the AIS injury coding system and the benefits and associated problems of using this coding system.

+ to be exposed to some biomechanical concepts, that can assist in understanding injury causation.

297

Outline

- Collecting injury data
 - Why do we have to collect injury data?
 - Types of injury data and sources
 - Core variables
- Introduction to injury coding
 - ICD
 - AIS and derivatives: MAISS, ISS, NISS.
 - Others
- Identifying causes
 - Anthropometry
 - Injury criteria
 - Vehicle interior inspection
 - Vulnerable road users
 - Core variables

298

Collecting injury data

- Why do we have to collect injury data?
- Types of injury data and sources
- Core variables

The first part of the presentation covers three items:

+ Why do we need to collect injury data?

++ Different types of injury data and sources that are available

+++ A few core variables providing general information on injury and medical data.

299

INJURY: A PUBLIC HEALTH PROBLEM 5 million injury deaths per year: 1.2 MV

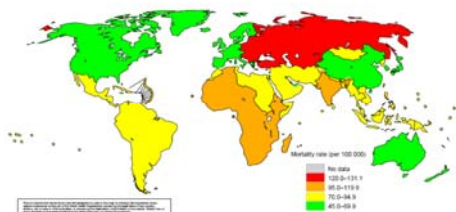

Injury-related mortality rates (per 100 000 population) in WHO regions, 2006									
Africa	Americas		South-East Asia		Europe		Eastern Mediterranean		Western Pacific
LMIC	HIC	LMIC	India	Other LMIC	HIC	LMIC	HIC	LMIC	HIC
118.0	53.0	76.2	90.9	75.0	47.6	131.5	51.1	70.4	56.2
									51.5
									78.4

Source: WHO, 2006

+ The problem of motor vehicle crashes is mainly a PUBLIC HEALTH problem, that results in a large number of fatalities and injuries worldwide.

++ 1.2 million people per year die as consequence of motor vehicle collisions. And this is particularly important in some countries from Eastern Europe, Asia, Africa and Central and South America. In many of these countries the number of vehicles is going to increase substantially in the coming years with the more than likely subsequent increment in fatalities and injuries.

+++ 137 MV DEATHS EVERY HOUR

300

DaCoTA Deaths in the world. Ranking by cause

Condition	2002	Expected 2030
Coronary Disease	1	1 =
Cerebrovascular Disease	2	2 =
Lower Respiratory Disease	3	5 ↓
HIV/AIDS	4	3 ↑
Chronic Obstructive Pulmonary Disease	5	4 ↑
Perinatal Diseases	6	9 ↓
Diarreic Diseases	7	16 ↓
Tuberculosis	8	23 ↓
Ca. of Trachea, bronchia & lung	9	6 ↑
Motor vehicle injuries	10	8 ↑
Diabetes Mellitus	11	7 ↑
Malaria	12	22 ↓
Hipertension	13	11 ↑
Self-inflicted injuries	14	12 ↑
Ca. of Stomach	15	10 ↑

Fuente: Mathers and Loncar PLOS medicine 2006; 3; 2011-2029 doi 10.1371/journal.pmed.0030442

+ Predictions given by the World Health Organization for 2030 show that this MV deaths are likely to increase from being the 10th cause of death in 2002 to becoming the 8th by 2030, worldwide.

++ and this is at the cost of emergent economies absorbing this increase of fatalities with an increased number of vehicles circulating on the roads.

301

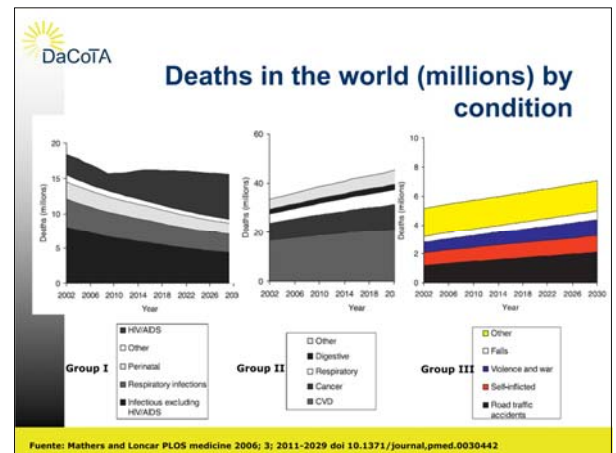

+ While many infectious diseases and others like HIV and respiratory infections are expected to decrease in the coming years, the prediction for injury related deaths is likely increasing during the following years. And this increase includes MV related fatalities.

++ Point out the amount of resources that countries dedicate to research on preventing infectious diseases and how much is dedicated to injury prevention (including traffic safety).

302



Focusing on the situation in Europe, this is the injury pyramid for EU-27 as published by WHO - Europe. When we talk about injuries, fatalities are just the tip of the iceberg.

+ Preventing fatalities would be the priority.

++ Need to prevent non-fatal injuries as well. Prevention in terms of disability, for instance. Prevention in terms of hospitalization costs.

303



The estimation of the cost related to MV injuries in the world was of 518 billion dollars in 2000. Which can be translated to about 1-2% of the gross domestic product.

+ The costs related to MV injuries are mostly indirect costs (productivity losses because of impairment, hospital treatment, long term disabilities, etc...) but these are really challenging to estimate.

++... so the best estimations are based on direct costs (the cost of the hospital treatment)

304

DaCoTA

Injury Prevention

- An adequate Injury Prevention strategy must be informed by real world data to:
 - Describe the magnitude of the problem.
 - Identify risk factors.
 - Assess the effectiveness of policies and countermeasures.

In summary, if we want to prevent injuries, we need to be base our efforts on REAL WORLD DATA so that we can

+ describe the magnitude of the problem. In other terms, how big the burden of MV injuries is, the circumstances in which crashes are happening, the main injury patterns MV casualties sustain.

++ identify risk factors: how driving at night modifies the risk of being involved in a crash, for example: how the risk of sustaining chest injuries increases without wearing the belt, and how it increases wearing the belt if you are older than 70 years old.

+++ assess the effectiveness of policies and countermeasures that are put in place: should the seatbelt be mandatory for all people in all positions

305

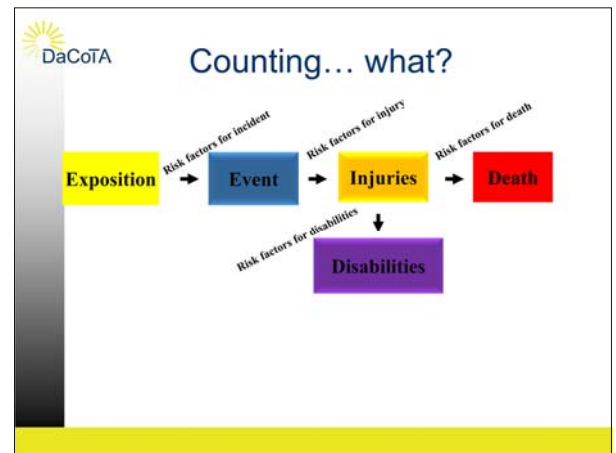

What kind of data should we collect? Depending on which is the question to be investigated. This slide summarizes the sequences of events that may lead to death or disability.

+ Starting from the end (final goal). We want to prevent disabilities/long term impairment and death. The needed but not sufficient cause for either death or disability to occur is INJURY.

+ and it is not sufficient because not all injuries ended up in death or causing disability, only under some circumstances the outcome is disability and death. These are the risk factors for disabilities and risk factors for death.

+ Taking a step backwards, for an injury to occur we need an event. And in MV crashes this even is what we call sometimes "accident" or crash. But not all crashes result in injuries. There must be a set of

306

concurrent circumstances so that an injury occurs.

+ and going even further, for an event to occur, we need to be exposed to the event and not always when we are driving we participate in a crash, so again there must be some factors leading to the crash.

306

DaCoTA

Injury Prevention

- "... the end results [MV injuries] could be achieved through recognition of the entire process, and of each and every one of the steps that contribute to the damage to be prevented" (Haddon, 1968)
- "... there is no logical reason why the rank order of loss-reduction countermeasures generally considered must parallel the sequence of causes contributing to the result of damaged people" (Haddon, 1970)

+ William Haddon was the first director of the American National Highway Traffic Safety Administration, the government agency in charge of traffic safety in the US. Haddon was a Medical Doctor and his main contribution was to frame the problem of traffic safety using the paradigm of infectious diseases. For an infection to spread out and affect the population you always need a host, a vehicle and an environment. And the combination of this triad (host, vehicle, environment) and the previous slide, gave origin to the famous matrix of Haddon.

++ Reading the original papers by Haddon in the late 60s and early 70s is highly recommended. They are very clear and very illuminating.

307

+++ Two quotes from Haddon:

1) the need of recognizing the whole process. And the whole process is what was presented to you in the previous slide. It is not enough to focus only on one of the steps, assuming there will not happen anything else down the flowchart. Because it will.

2) There is no reason to prioritize some interventions simply because they rank first in the term of causing the injury. We need to prioritize countermeasures according to their effectiveness in real life. And this means, again, that we need real data to assess the real world performance of policies and interventions.

307



DaCoTA

Sources of MV injury information

- Police reports
- Hospital records
- Insurance reports
- Dedicated information systems (i.e. DaCoTA)

+ Which are the sources we can tap in to obtain data? There are a variety of them and none of them is perfect. Each presents its advantages but also its drawbacks.

+ Without being exhaustive, it can be mentioned four big groups of information: police data, hospital records, insurance reports and research information systems such as Dacota.

308

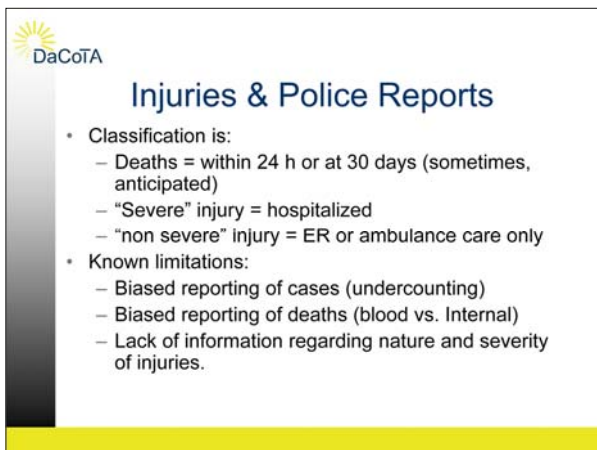

DaCoTA

Injuries & Police Reports

- Classification is:
 - Deaths = within 24 h or at 30 days (sometimes, anticipated)
 - "Severe" injury = hospitalized
 - "non severe" injury = ER or ambulance care only
- Known limitations:
 - Biased reporting of cases (undercounting)
 - Biased reporting of deaths (blood vs. Internal)
 - Lack of information regarding nature and severity of injuries.

Police reports

+ Dead, severe, slightly, no injury.

++ Definition of categories: death within 24 hours or 30 days?, severe injuries is admission to hospital.

309



DaCoTA

Injuries & Hospital Reports

- Classification is:
 - Descriptor of injuries → International Classification of Diseases (9th or 10th version depending on country and outcome)
 - Descriptor of outcome → live/death discharge
- Known limitations:
 - Relates to medical service use (under/over admission)
 - Unspecific nature of injury codes
 - Missing and unspecific mechanism of injury codes to identify victims as MV
 - Circumstances of the crash (type of impact, helmet)

+ very good description of injuries

++ underestimate of cases (killed on the spot or at the emergency room)

+++ ICD assigns code describing the nature of the injury and the mechanism by which the injury is produced. But sometimes this mechanism is unknown.

++++ Even if the mechanism is known, the information regarding the circumstances of the crash is very poor and insufficient. For instance, impossible to know if injured motorcyclists were using helmet.

310

DaCoTA

Injuries & Insurance Reports

- Classification is:
 - Arbitrary depending on company/country
 - At most, it follows legal categories of disability
- Known limitations:
 - Relates to economic compensation
 - Lack of injury codes
 - Unspecific disability codes
 - Private: protection personal data

Another source of information are the records from insurance companies, although these are extremely difficult to get due to the protection of personal data and that somehow can be easily linked to personal finances.

+ each company has its own system and records, and they do not necessarily follow a standard.

+ a feature that makes these systems special is that they normally contain information about disability.

311

DaCoTA Non-fatal injuries (hospital discharge data), Barel matrix. 16 EU countries (ca. 2004, N=2.4x10⁶ people; 2.9x10⁶ diagnosed injuries)

	Fracture	Dilatation	Internal	Open wound	Amputations	Blood Vessels	Contusion/superficial	Crush	Burns	Others	Unspecified	TOTAL
Traumatic brain injury	1.5		10.4	1.1				0.5		0.2	0.1	13.7
Other head	2.6		0.3	1.8			1.6		0.1	0.1	0.1	6.6
Neck	0.1			0.1						0.2		0.5
Neck and head other							1.0		0.2			1.2
Spinal cord	0.2		0.2									0.4
Vertebral column	3.0	0.1								1.3		4.5
Thorax	2.8		1.2	0.1			1.0		0.1	0.2		5.3
Abdomen, pelvis, trunk and lower back	1.8		1.1	0.3			1.5		0.2	0.3	0.3	5.5
Upper Extremity	13.2	1.4		2.1	0.5	0.1	0.9	0.1	0.4	1.9	0.1	20.8
Lower extremity	12.3	1.1		0.6	0.1		1.1	0.1	0.2	3.8	0.2	19.4
Hip	10.0	0.3					0.5			0.1		11.0
Multiple body regions, system wide and unspecified	0.4	0.0		0.7		0.1	1.0		0.6	1.0	7.2	11.0
TOTAL	48.0	3.0	13.2	6.7	0.6	0.3	8.6	0.8	1.8	9.0	8.0	100.0

This is the so-called Barel matrix and classifies the injuries according to the nature of the injury and the body region. And it allows to identify which injuries (and where) are the most frequent.

312

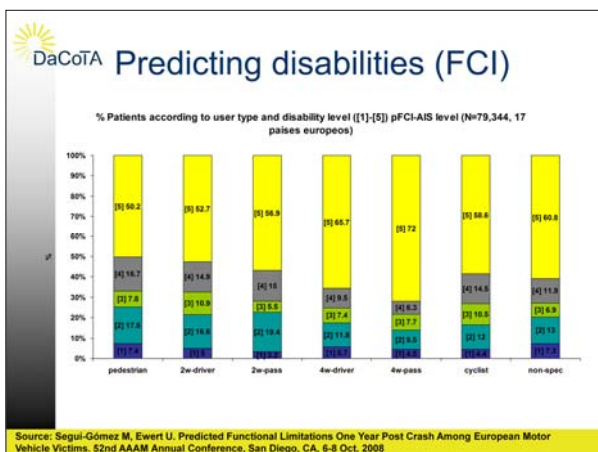

This is another study in which the original data were ICD codes and several algorithms were used to translate them into a scale called FCI that classifies disabilities.

These are the percentage of patients sustaining disability (1: no disability 5: seriously disabled) and compared across different types of road users. Pedestrian and 2-wheeler passengers are the most frequent disabled user groups.

313

DaCoTA Variables within DaCoTA db

- Police Injury Severity (varid: 227)
- Dead
- Dead Due To The Accident
- Number Of Days Until Death
- Number Of Days in Hospital

314

Introduction to injury coding

- ICD
- AIS and derivatives: MAISS, ISS, NISS
- Other scales

315

Several existing injury descriptors

- ICD (International Classification of Diseases)
 - International standard to classify each and every health condition (WHO)
 - Injuries described by 'external cause of injury' or by 'body region and nature of injury'.
- Anatomically based: AIS, ISS, NISS
- Physiologically based: TRISS, RTS, Glasgow
- Disability based: FCI
- Costs

+ ICD and the AIS were developed in parallel and they are redundant up to a certain point. The main difference is that the AIS does include a severity assessment, while the ICD does not have it. In terms of the description of the injury both systems could be considered equivalent.

316

Dimensions of Severity

A number of severity scales have been developed over the last 50 years with different goals. Each focuses on a particular dimension of severity.

Among the possible dimensions:

- | | |
|---------------------------------|------------------------|
| • Threat to life | • Treatment complexity |
| • Tissue damage | • Length of treatment |
| • Mortality | • Disability: |
| • Energy dissipated or absorbed | temporary/permanent |
| • Hospitalization: ICU, LOS | • Permanent impairment |
| • Cost | • Quality of life |



317

AIS: Abbreviated Injury Scale

Concepts and purpose:

- To facilitate the classification of injuries attending to the anatomic nature of the injury and its severity.
 - Severity unaffected by time, consequences or outcome
- Standardize terminology
- Usable for multiple injury causes/mechanisms
- Describe injury anatomically
- More than a threat-to-life scale

+ Goal: classify injuries according to:

- 1- anatomy
- 2- severity (regardless of time, location or outcome)

+ Establish a common terminology

+ Independent of the actual injury mechanism (and therefore, applicable to all injuries)

318

AIS Definition

An anatomically-based, consensus-derived, global severity scoring system that classifies each injury by body region according to its relative importance on a 6-point ordinal scale.

319

AIS Definition

- Anatomically-based
 - Clinical training not necessary
 - Measurements not variable or affected by
 - Time from injury to treatment
 - EMS
 - ETOH or drugs
 - Age
 - Ability to compensate for volume loss

+ the injury severity is not affected by care delivery, or alcohol consumption, or age, or gender... One might want to code all these variables, but they are independent of the actual injury

320

AIS Definition

- Consensus-derived
 - Developed by panel of experts
 - Different areas of expertise
 - Years of experience
 - Agree to agree

+ This is the main criticism to AIS: it was derived by consensus among a group of experts that met in the 60s.

+ Experts w/ different areas of expertise and that were committed to reach consensus about the severity of the injuries. No computers, no electronic data, no comparison between different settings/countries, etc... They wanted to consider all the aspects related to the injury: probability of death, long-term disability, cost...

+ The experts did a good job. The scale has been updated over time, but it has been shown to have a good correlation with the likelihood of death for instance.

321

AIS Definition

- Global Severity Measurement
 - Determinable once and not contingent on long-term outcome
 - *Femur fracture = AIS-3*
 - Severity is invariant with time
 - *Day 1 injury severity = Day 10 injury severity*

+ It is a global measurement:

+ if a patient with a femur fracture (AIS 3) dies, we cannot go back and change the AIS score of that injury to 6. It is what it is as dictated by the dictionary, regardless of the outcome.

++ the severity does not change upon time.

322

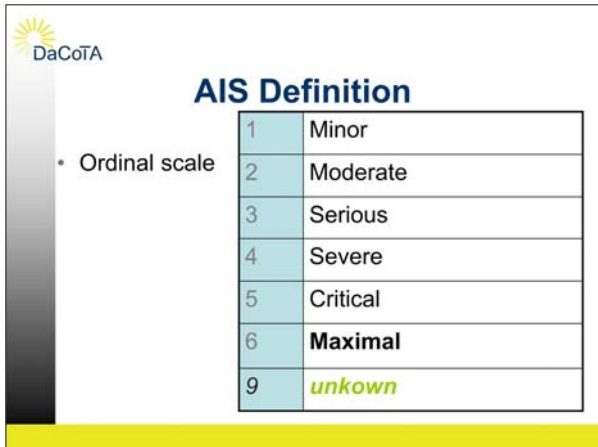

+ These are all the possible AIS severity scores in the scale.

+ Not all AIS 6 injuries mean automatic death. You can have an AIS 3+ w/ other comorbidities and die. Only a few AIS 6 are associated to direct death as for instance decapitation.

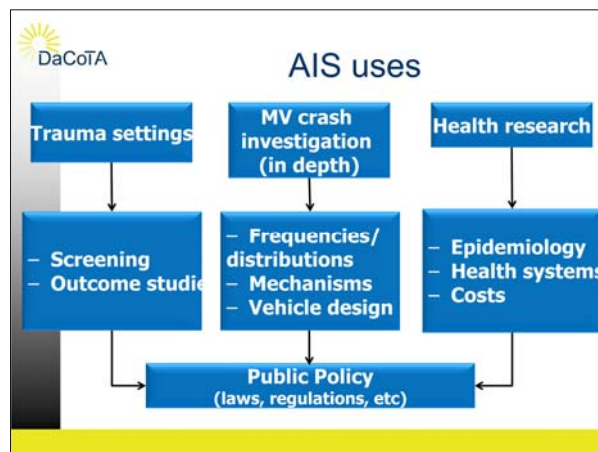

AIS can be used in several different environments and with different focus depending on its use. It can benefit several of the agents doing research/policy in injury prevention.

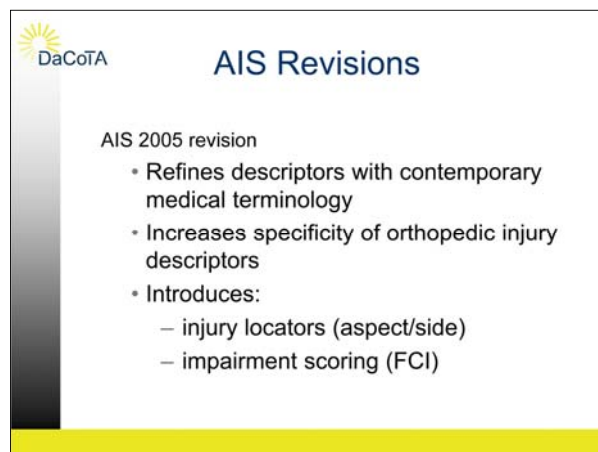
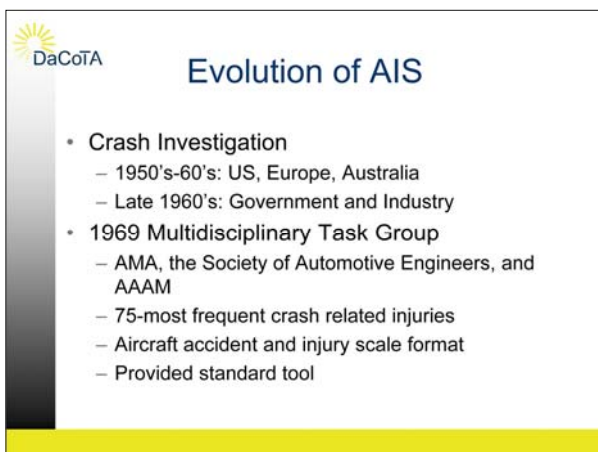

There have been a number of revisions of the AIS. The last one is the 2005 revision, that was updated in 2008 without constituting a new revision. Currently the dictionary contains some 2000 injuries and there is an ongoing AIS committee that meets periodically to monitor the development of the scale.

+ Changes have been basically adding new codes to the dictionary, changing the severity a few ones and providing more information. Also about adding injuries caused by other mechanism or updating medical terminology (mainly in the first revisions)

+ In the 2005 revision, on top of the 7 digits, there are two more that indicate the location of the injury (superior, inferior/ medial, lateral) and the predicted FCI (from 1-5). Caution, this prediction is not completely validated.

+ also in the last revision, there was a common effort with the orthopedic college of America to update the severity of some injuries.



Anyone interested in knowing the story and the evolution of the AIS throughout the years, should read the introduction of the AIS dictionary. In a few pages you will get an excellent overview of the main changes that the scale has undergone over the years.



Currently, the AIS dictionary has been translated into 7 different languages

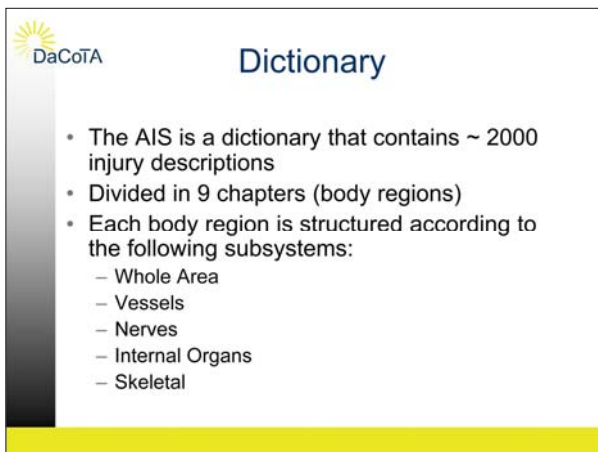

+ an important note is that not all the severities can be found in all body regions. For instance in the extremities there is not AIS 6.

DaCoTA AIS 2005 Dictionary entry Includes:

- Pre-dot code
- AIS severity number
- Injury description
- Cross references to AIS 98 and FCI

Each entry of the dictionary is formed by a pre-dot code, the AIS number, a descriptor and the translation into the 98 version and the predicted FCI.

DaCoTA Severity Coding: important remarks

- Per se, 'death' is not part of severity scale
- AIS-4 is not twice AIS-2
- Injuries with same code may not be strictly compatible
 - AIS 3 *Head Region vs Extremity Region*
- AIS-9 = *unknown*
 - Inadequate information

DaCoTA Severity Number

- Relative severity of injury in an *average* patient with only that injury
- What is an 'average' patient?
 - 25-40 years
 - No pre-existing conditions
 - No treatment complications
 - Timely, appropriate care

DaCoTA AIS-6 -examples

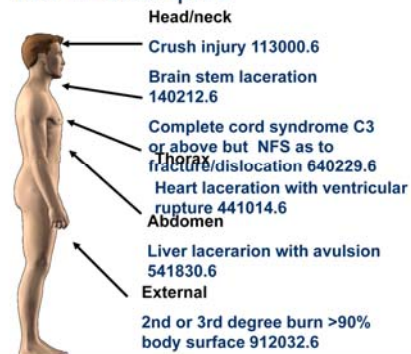

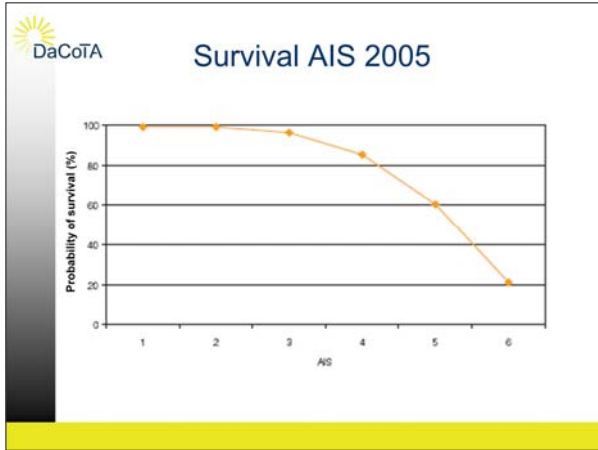

This curve shows the probability of survival as function of the AIS index.

Multiple Injuries

- AIS – considers severity of a single injury. Thus, it does not describe correctly the severity of a patient with multiple injuries. Other AIS-based scales address this shortcoming.
- MAIS – maximum AIS is the simplest one.

Injury Severity Score

- ISS (Susan Baker et al, 1971)
 - Weighted system – uses highest AIS in 3 body regions
 - Hospital, epidemiology
- ISS is the sum of the squares of the highest AIS in each of the three most severely injured ISS body regions:

$$A^2 + B^2 + C^2 = ISS$$
 (where A, B, and C represent the 3 most severely injured body regions)

Other scales have been developed to include the effect of the combination of multiple injuries.

Injury Severity Score

These are the areas considered in the calculation of the ISS:

1	Head and Neck
2	Face
3	Chest
4	Abdominal / Pelvic Contents
5	Extremities/ Pelvic Girdle
6	External

Injury Severity Score

- Reason for development of ISS
 - There is a non-linear relationship between maximum AIS (MAIS) and mortality
 - Higher mortality is dependent upon second injury
 - Summation of AIS is inadequate to describe the probability of death. For example:
 - AIS-3 + AIS-4 = 7 (24%)
 - AIS-5 + AIS-2 = 7 (54%)

Injury Severity Score

- Rationale:
 - Relationship of combined effects of injuries
 - Comparable ISS implies similar mortality rates
 - ISS shows better correlation with death rates

Example:

	AIS Score
<u>Small subdural haematoma</u>	4
<u>Parietal lobe swelling</u>	3
<u>Major liver laceration</u>	4
<u>Upper tibial fracture (displaced)</u>	3

ISS = 4² + 4² + 3² = 41

Injury Severity Score

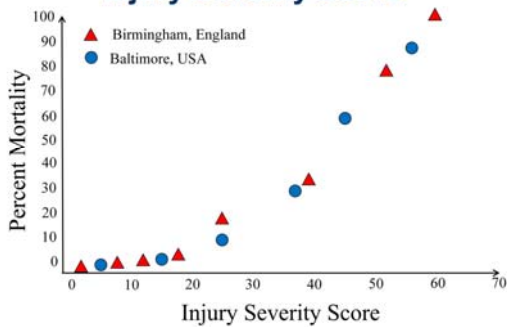

Source: Baker SP, O'Neill B, Haddon W, Long WB. The Injury Severity Score: a method for describing patients with multiple injuries and evaluating emergency care. *J Trauma* 14:187-96, 1974.

Validation of the ISS in two different locations. Reference is given at the bottom of the slide.

Injury Severity Score

- There are several criticisms of the ISS (apart from the intrinsic ones to the AIS itself):
 - ISS does not take into account multiple injuries within the same body region.
 - ISS gives equal weights across body regions (it might underscore severe head injuries)

DaCoTA **New Injury Severity Score**

- NISS – New ISS
 - Sum of the squares of the three highest AIS in any ISS body region
 - Defined by Baker (Baker S. Advances and adventures in injury prevention. J Trauma: Injury Infect Crit Care 42:369-73, 1997)
 - Comparison with ISS:

	<u>AIS Score</u>	<u>Region</u>
Multiple abrasions	1	External
Deep laceration tongue	2	Face
Subarachnoid hemorrhage	3	Head/Neck
Major kidney laceration	4	Abdomen
Major liver laceration	4	Abdomen

$$\text{ISS} = (4)^2 + (3)^2 + (2)^2 = 29$$

$$\text{NISS} = (4)^2 + (4)^2 + (3)^2 = 41$$

Another scale developed after ISS

DaCoTA **www.aaam.org**

The screenshot shows the AAAM website with a navigation menu and a main content area titled 'Trauma Care'. The text in the main area reads: 'Dedicated physicians and researcher members of AAAM work around the clock to improve the triage and treatment of victims of motor vehicle crashes.' There are also buttons for 'Member Login', 'Request Membership', 'Join Now', 'Join Our Mailing List', and 'Publications'.

Please, visit the AAAM official website to get more information about the AIS and how you/your organization can be trained on AIS coding

DaCoTA **Physiologically based injury-severity scales**

Glasgow Coma Scale (GCS)

- Assess the severity of the injury based on the impact of the injury on the physiology of subject.
- Ranges from 3 (profound coma) to 15 (perfect state).
- Derived from verbal, eye and motor responses in a 1-5 ordinal point basis each summed up
- ONLY for traumatic brain injury patients

Apart from the AIS, there are other scales to assess the severity of injuries. The Glasgow Coma Scale is one of them using only for traumatic brain injuries.

DaCoTA **Physiologically based injury-severity scales**

Parameter	Response	Score
Eye opening	Nil	1
	To pain	2
	To speech	3
	Spontaneously	4
Motor response	Nil	1
	Extensor	2
	Flexor	3
	Withdrawal	4
	Localising	5
	Obeys command	6
Verbal response	Nil	1
	Groans	2
	Words	3
	Confused	4
	Orientated	5

Scores used in the derivation of the GCS.

DaCoTA Physiologically based injury-severity scales

Revised Trauma Score

- $RTS = f\{GCS + \text{respiratory frequency} + \text{arterial pressure}\}$

Trauma Revised Injury Severity Score

- $TRISS = f\{RTS + \text{injury mechanism (blunt vs. penetrating)} + \text{age} + ISS\}$

Other scales based on combination of different scores (GCS and ISS for instance)

DaCoTA

Identifying causes

- Anthropometry
- Injury criteria
- Vehicle interior inspection
- Vulnerable Road users
- Core variables

DaCoTA

Anthropometry

Nomenclature used when referring to anatomical regions.

DaCoTA

Injury criterion

- The value of the injury criterion indicates the probability of sustaining an injury of a specific severity.
- They are formulated as injury risk curves (cumulative probability)

Injury criteria predict the probability of injury (normally expressed as probability of sustaining a specific AIS severity injury) as function of a physical magnitude (force, acceleration, displacement)

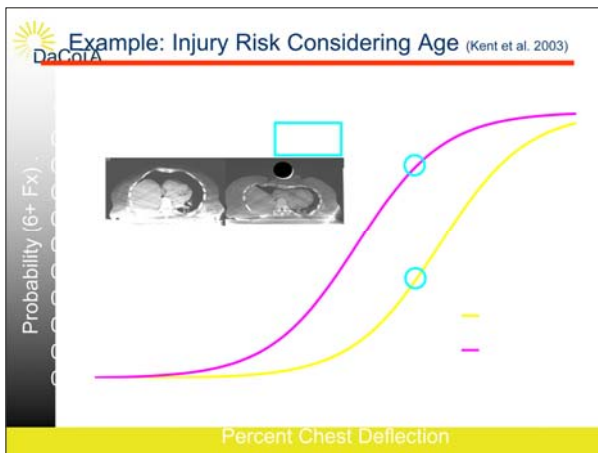

Injury criteria are based on extensive cadaveric experimental testing.

351

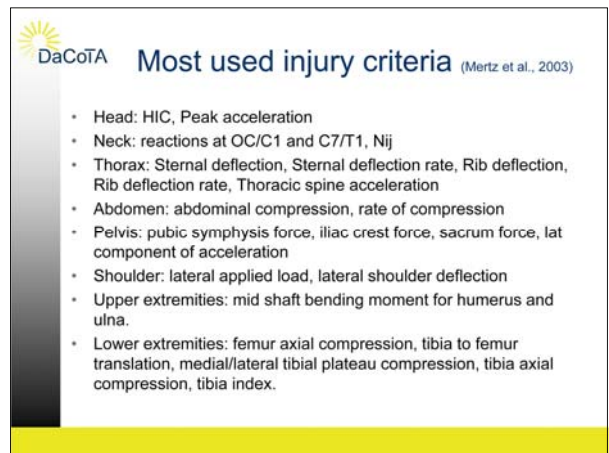

This slide provides a summary of different injury criteria that have been defined over the last years. It does not pretend to be an exhaustive list, since there is a lot of ongoing research to improve and propose new criteria.

352

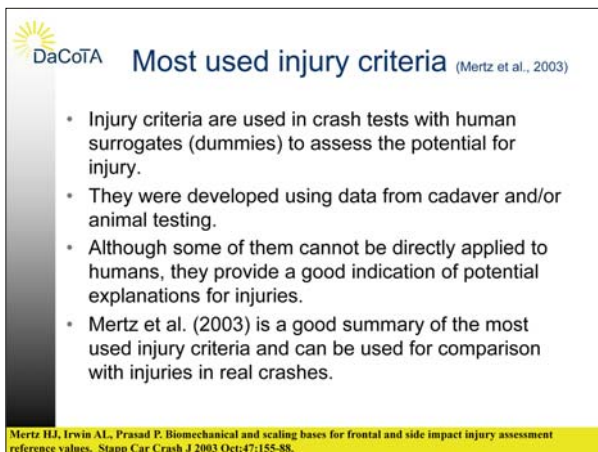

Please, check the reference at the bottom to get a comprehensive description of the most commonly used injury criteria and how they have been adapted to different sizes of occupants.

353

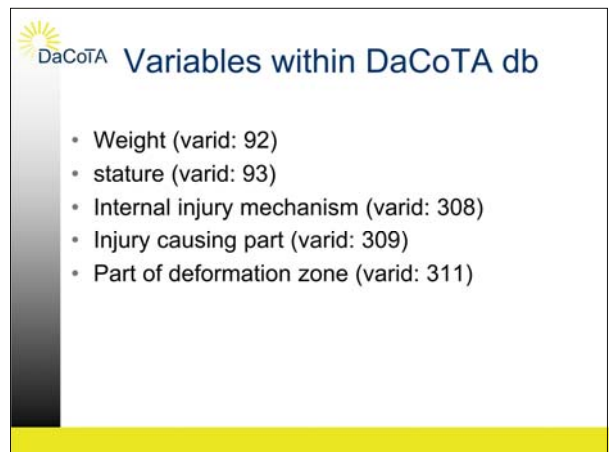

354

DaCoTA

Case 1

- Offset frontal impact.
- Blue van crossed over the other lane impacting the red car.
- 8 YO restrained by lap and shoulder belt (126 cm, 27 kg), right rear seat.

A

355

DaCoTA

Case 1

Injury description	AIS
Jejunum-ileum laceration perforation	5414243
Mesentery laceration	5420222
Abdomen skin contusion	5904021

A

356

DaCoTA

Case 2

- Offset-frontal impact.
- V1 driver lost control and crossed over the opposite lane, impacting V2. Estimated delta-v= 75 km/h
- 31 YO female driver. Belted. Airbag deployed. 160 cm, 81 kg.

A

357

DaCoTA

Case 2



Injury description	AIS
Rib cage fx >3 on each of two sides w/ pneumothorax	4502425
Aorta thoracic laceration; perforation; minor	4202084

A

358

Case 2



Injury description	AIS
Rib cage fx >3 on each of two sides w/ pneumothorax	4502425
Aorta thoracic laceration; perforation; minor	4202084





There was an impact with the steering wheel. Even if the restraint systems worked properly, the delta-v of the crash was very severe and the driver was likely driving very close to the wheel, what might have impacted the ability of the airbag to control the forward motion of the occupant.

359

Case 3





- **Offset-frontal impact.**
- **V1 driver fell asleep and crossed over the opposite lane, impacting V2. Estimated delta-v= 66 km/h**
- **51 YO female driver. Belted. Airbag deployed. 170 cm, 83 kg.**

360

Case 3







Injury description	AIS
Pelvis fx open left	8526043
Bladder laceration perforation	5406244
Pelvis fx open anterior	8526043



Case 3



Injury description	AIS
Pelvis fx open left	8526043
Bladder laceration perforation	5406244
Pelvis fx open anterior	8526043

Pelvic fractures caused likely by the intrusion of the dashboard in the occupant compartment.

361

362

DaCoTA Case 3

Injury description	AIS
Cerebrum diffuse axonal injury	1406285
Cerebellum diffuse axonal injury	1404065
Cerebellum subarachnoid hemorrhage	1404663
Cerebrum subarachnoid hemorrhage	1406843

Difficult to check for potential contact points of the head due to the extrication of the passengers.

DaCoTA

VRU Injury

Dimitri Margaritis
CERTH/HIT

Project co-financed by the European Commission, Directorate-General for Mobility and Transport

The following slides contain a brief summary of some European studies providing information on the distribution of injuries from different types of vulnerable road users. The references to the complete studies are given in the slides.

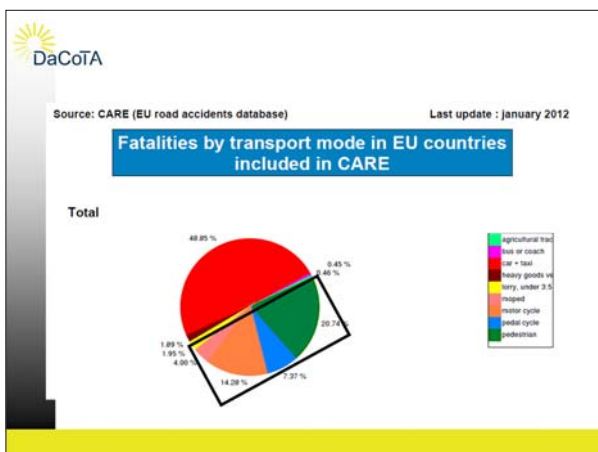

DaCoTA

PTW occupant injuries

366

PTW injuries (MAIDS experience)

Table 1 - PTW rider trauma injury	Frequency	Percent
No trauma	3	0.3
First aid only	29	2.4
Outpatient	4	0.4
Hospital treatment up to 6 days	522	56.8
Hospital treatment more than 6 days	121	13.1
Hospital treatment unknown number of days	142	15.4
Fatal within 30 days	3	0.3
Fatal unknown number of days	2	0.2
Documented after 30 days	1	0.1
Unknown	7	0.8
TOTAL	1001	100.0

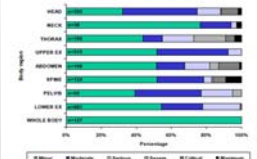
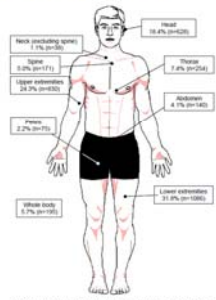

Summary of the distribution of PTW rider injuries greater than AIS=1

Contact codes (MAIDS experience)

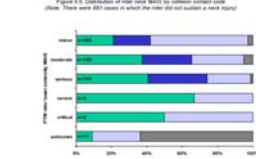
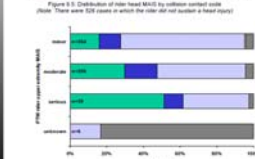
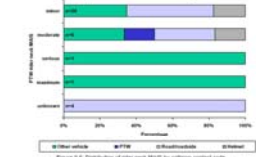
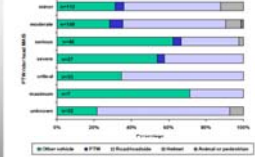

Pedestrian injuries

Pedestrian accidents (Pendant experience)

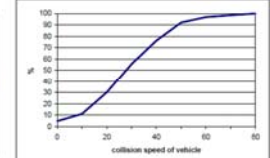
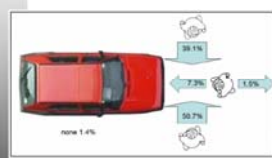

n 15: Walk direction of n=63 pedestrians

n 16: Cumulative frequency of collision speed of collision partner of n=63 pedestrians (n=6 not known)

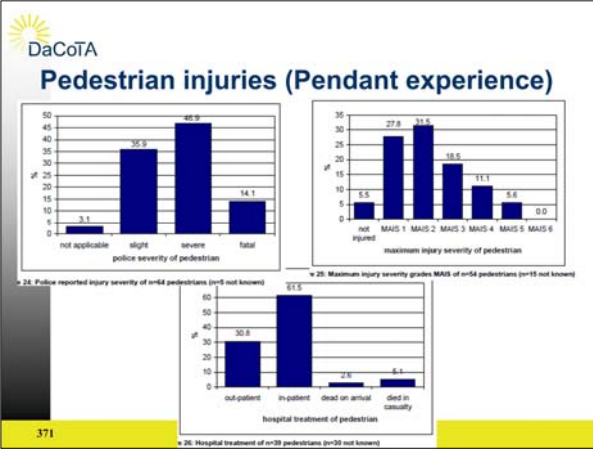

371

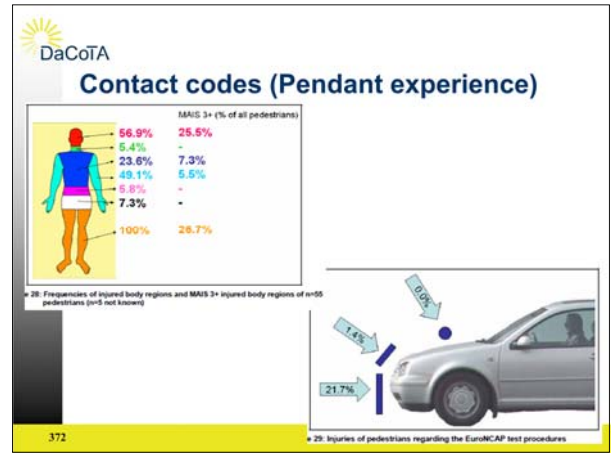

372



373

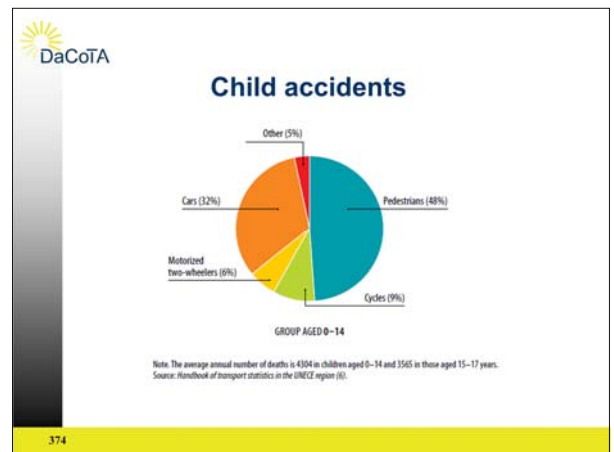

374

Child injuries

RTIs to 1304 children younger than 12 years, discharged from hospitals in 10 European countries, 2004

Site	Type										Total (%)
	Fracture	Dislocation	Internal	Open wound	Amputations	Blood vessels	Contusion/Superficial	Crush	Burns		
Traumatic brain injury	124	0	531	142	0	0	0	99	0	896 (43)	
Other head	72	10	0	71	26	1	156	0	0	336 (16)	
Neck	0	0	0	0	1	0	13	0	0	14 (1)	
Neck and head other	0	0	0	0	0	0	44	0	1	45 (2)	
Spinal cord	3	0	0	0	0	0	0	0	0	3 (0)	
Vertebral column	16	1	0	0	0	0	0	0	0	17 (1)	
Thorax	14	0	18	1	9	1	57	0	0	100 (5)	
Abdomen, pelvis, trunk and lower back	20	1	73	6	22	1	114	0	0	237 (11)	
Upper extremity	143	2	0	28	4	0	28	1	1	207 (10)	
Lower extremity	134	1	0	25	9	0	47	1	1	218 (10)	
Hip	17	3	0	0	4	0	3	0	0	27 (1)	
TOTAL	543	18	622	273	75	3	462	101	3	2100 (100)	

Source: Lopez-Valdes et al. (33)



Special thanks to NHTSA-CIREN for sharing the detailed injury information shown in Cases 1, 2 and 3.

We would also to thank Rebeca Abajas (ECIP) for her help in coding the injuries of the victims of the practice case.

Francisco J. Lopez-Valdes
Research Assistant
fj12j@virginia.edu



Universidad de Navarra

European Center for Injury Prevention

Case Analysis

Accident Type Coding

Helen Fagerlind, Chalmers/SAFER



Directorate-General for Mobility and Transport

Project co-financed by the European Commission, Directorate-General for Mobility and Transport

Accident Type Coding

- Two types of coding
 - DaCoTA accident type
 - Conflict based
 - Can be used for accident causation analysis
 - CADAS accident type
 - For comparison with CARE
 - Event description

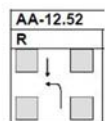
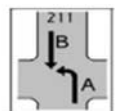

Dacota Accident Type

- Coding the conflict situation which led to the accident
- Not based on which road user might caused the accident
- Not impact configuration

379

Dacota Accident Type

- Type 1: Driving Accident
 - Due to loss of control of the vehicle
 - Normally single vehicle accident
- Type 2: Turning Off Accident
 - Conflict between road user turning and a road user coming from the same or opposite direction
- Type 3: Turning In/Crossing Accident
 - Conflict between a turning in or crossing road user without priority and a vehicle with priority



380

Dacota Accident Type

- Type 4: Pedestrian Accident
 - Conflict between a vehicle and a pedestrian on the road
- Type 5: Stationary Vehicle Accident
 - Conflict between a moving vehicle and a vehicle which is standing still
- Type 6: Longitudinal Traffic Accident
 - Conflict between road users moving in the same or in the opposite direction

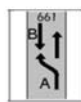
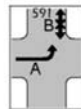
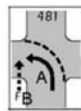

381

Dacota Accident Type

- Type 7: Other Accident
 - An accident that is not applicable to accident types 1-6

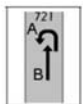

382

CADAS Accident Type

- A-8: Accidents with pedestrians
- A-9: Accidents with parked vehicles
- A-10: Single vehicle accidents



CADAS Accident Type

- A-11: At least two vehicles - no turning
- A-12: At least two vehicles - turning or crossing



Accident example







Accident example Sequence of event

- A 50-year old man is driving northbound in vehicle 1.
- A 20-year old man is driving southbound in vehicle 2.
- The man in vehicle 2 overtakes another car (vehicle 3) and is driving in high speed. He starts to skid in a right curve and fails to get the car under control again. The car is on the wrong side of the road when the two cars meet. The driver of vehicle 1 brakes but fails to stop in time.
- There is a frontal collision between the cars.
- Vehicle 2 ends up in the ditch and vehicle 1 remains on the road.

DaCoTA

Accident Type

- **Dacota**
 - Type 1: Driving accident
- **CADAS**
 - A-11.01 At least two vehicles, same direction, overtaking
 - A-11.06 At least two vehicles - head on collision in general
 - A-10.07 Single vehicle accidents in a bend, going either side of the road

The Dacota accident type only describes the conflict situation which initiated the accident therefore the accident type is coded as loss of control in a right curve.

CADAS accident type is rather an event description of the course of event and up to three event can be coded. In the example vehicle 2 first overtake vehicle 3 (A-11.01). Then it collides with vehicle 1 (A-11.06). After the collision vehicle 2 runs of the road (A-10.07).

387

DaCoTA

The DaCoTA On-line Manual

G. Giustiniani, R. Carroccia, M. Robibaro
Research Centre for Transport and Logistics - CTL, University of Rome, Italy

Project co-financed by the European Commission, Directorate-General for Mobility and Transport

388

DaCoTA

Summary

- Introduction
- Structure
- Main functions
- An example

389

DaCoTA

Introduction

- The aims of the **DaCoTA On-line Manual** are:
 - To provide a location for the DaCoTA in-depth road accident investigation methodology, developed by **DaCoTA Work Package 2 partnership**.
 - To inform on scope, characteristics and practical requirements of the methodology.
- It also contains detailed information on all variables (and fields) in the **DaCoTA system**.

390

DaCoTA Structure of DaCoTA on-line manual

- The manual contents are divided into 6 parts
 - Introduction and Acknowledgments
 - DaCoTA teams
 - Methodology outline
 - Variables
 - Detailed methodology
 - Forms and documents

391

DaCoTA Welcome page to DaCoTA On-line Manual

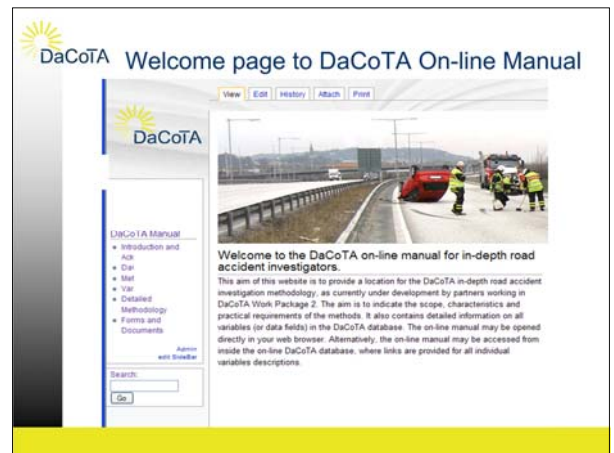

This is the first page of the DaCoTA on-line manual. From this page it is possible to browse it or to search for specific a variable.

392

DaCoTA Main Functions

- The Main Functions of the manual are:
 - View
 - The page you are viewing
 - Print
 - To print the **last version** of the page (it's a "living document")
 - E.g.: Page last modified on November 15, 2011, at 07:40 AM
 - Search
 - To search for e.g. variables
- The administrators also have the possibility to edit, attach or view history of changes

393

DaCoTA An Example: Accident Variables

- List of Variables related to the accident

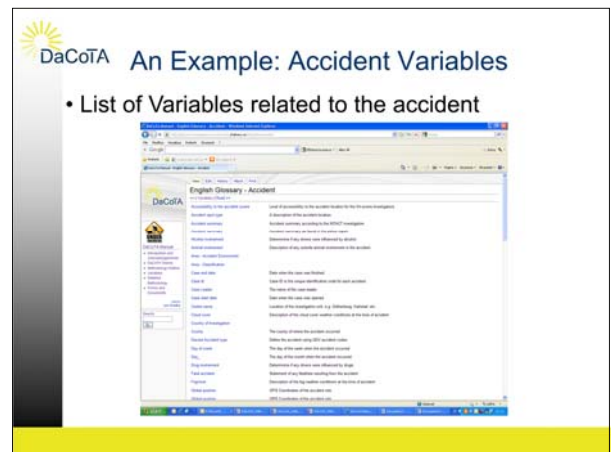

This is the list of variables available on the on-line manual. Just clicking on variable name it is possible to see the variable page where detailed information on the variable are reported

394

DaCoTA Another example: Photo Routine

2.1 Car

2.1.1 Exterior photos car

Take eight photos around the car from the angles shown in the photo below. Also try to take a photo on the car from above to see deformations of the roof, if any.

The diagram illustrates the required photo routine for a car. On the left, a central car icon is surrounded by eight camera angle icons: front, rear, left side, right side, front-left, front-right, rear-left, and rear-right. On the right, a 2x4 grid of photographs shows a red car from these eight perspectives. The top row shows front, rear, left side, and right side views. The bottom row shows front-left, front-right, rear-left, and rear-right views.

This page shows how to take pictures of a vehicle involved in the accident.

For all the activities related to an in-depth accident investigation similar pages are reported in the on-line manual.

DaCoTA

The Pan-European In-Depth Accident Investigation System

G. Giustiniani, R. Carroccia, M. Robibaro
 Research Centre for Transport and Logistics - CTL, University of Rome, Italy

Project co-financed by the European Commission, Directorate-General for Mobility and Transport

DaCoTA

Summary

- Overview of DaCoTA system;
- Local and Central systems;
- DEMO.

DaCoTA

What is the DaCoTA System?

DaCoTA System is a platform developed to:

- Store in-depth accident data in a harmonized manner
- Analyze and filter the accidents collected
- Exchange in a secure way data collected and the analysis results among the partners involved

The DaCoTA system has been developed starting from the SAFER system developed in Sweden for Swedish in-depth investigation activities.

The DaCoTA system has been improved and adapted to the DaCoTA needs.

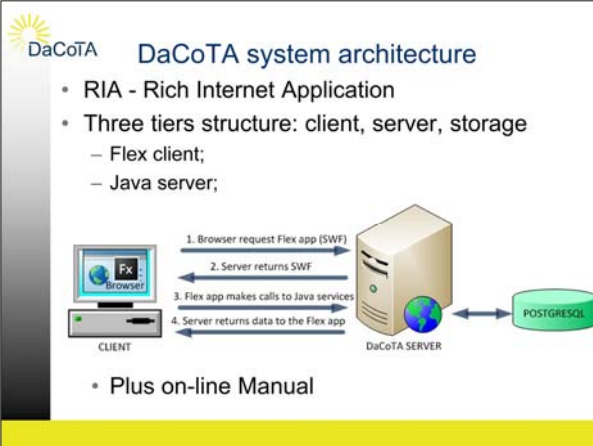

The System is a Rich Internet Application (RIA) and needs the use of the right set of technologies to provide the service.

The system utilizes Flex for the client, Java technology for the server, and PostgreSQL for the back-end database.

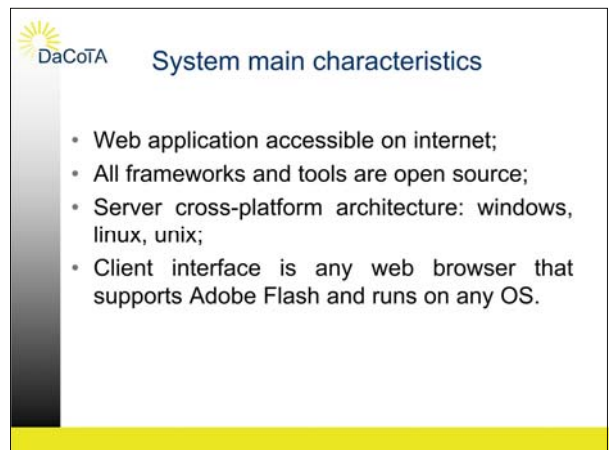
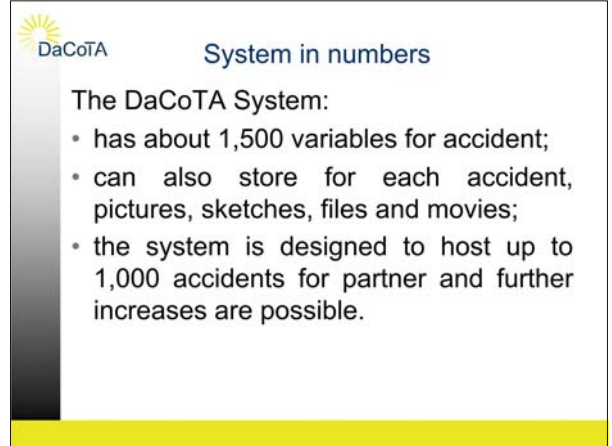

Important to know that, once the sever is installed and an internet connection is available, users can use it easily and on every computer with any web browser (Internet explorer, Mozilla, Chrome..)

Central System (CS) and Local Systems (LS)

- The System is split into two:
 - Central System at CTL available for all;
 - LSs for partners that prefer to store data locally before sending to the CS.
- The CS and the LSs have the same core software: every bug fixing or modification done on the core application will be sent to the partner with LS;
- The difference between the LS and the CS is in the server-configuration table saved on the DB. The Server will work as CS or as LS reading this configuration table

The local systems are needed for those partners that want to have data stored also locally in their server.

CS and LS - First choice

Do you prefer to use Central System?

- During the DaCoTA project CTL will be the Administrator (save time of your IT personnel);
- You do not need to buy a server (save money);
- But your data will be located in Italy (you can download it when you want of course and you own the data you enter);
- At the end of the project the CS will not be maintained anymore by CTL.

Do you prefer to use a Local System?

- Your data will be located in your server and only a copy will be sent to CS in Italy;
- But you need to have skilled IT personnel to administrate the LS;
- You need to buy and manage a server.

Start thinking about it.....

This slide explain the main differences between using local and central system.

Unless the research centre is provided with skilled IT personnel for the DaCoTA it is strongly suggested to use CS for the DaCoTA demo.

Using the CS a research centre to enter and analyse in-depth data need only a computer and an internet connection.

Functional model

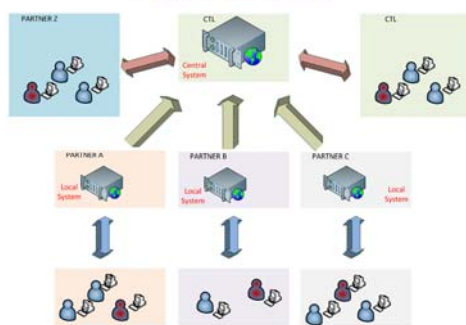

Data input and admin functions for LS

- Each partner could have a LS to store its data and IT skilled personnel should install it;
- Each LS has a main contact (admin) that can operate with administrative role and can:
 - Activate the application;
 - Create new local users with different roles;
 - Create and give rights to other partners for browsing accident cases;
 - Configure the SMTP server;
 - Upload accident cases to CS;
 - Export data in CSV format on the local file system.



Data input and admin functions for CS

- Users without LS and CTL will insert their data in CS;
- CTL will act as admin of CS and will:
 - Create new users for CTL;
 - Create new users for partners using CS (if required by partner);
 - Configure SMTP server to send e-mail;
 - Each partner using CS will be able to insert, save and publish only its cases.



Accident Case Status

- The accident Case can have three different status:
 - Work in progress
 - Published
 - Case progress 100% except Long Term Injury (necessary condition)
 - Finished
 - Case progress 100% and Long Term Injury 100% (necessary condition)

A research centre can browse all its cases and modify them.
On the other hand a research centre involved in DaCoTA demo will be able to browse, but not modify, only published or finished cases of the other research centres.

407

408



Transfer data from LS to CS

- Accidents ready to be uploaded from LS to CS, can be uploaded by the LS admin;
- The data that can be transferred from LS to CS consist of:
 - Images and Files associated with the accident cases
 - Data from DB tables regarding the cases
- The data transfer uses an SFTP protocol protected by username and password with an encrypted data channel.



Data browsing

- Each LS user can browse accidents on its LS with the role assigned by local admin and browse published accidents in CS;
- Each CS user can browse its accidents and other partners published accidents on the CS.
- The local admin can give access to its System with well defined rights;
- The central admin can give access to the CS with well defined rights.

409

410



Client requirements

- **Browser:**
 - Any internet browser (Mozilla Firefox, Internet Explorer, Chrome)
 - Adobe flash player 10;
 - Optimized for a screen resolution of at least 1280 X 1024.

To use the CS any partner can use a computer that meet these requirements.



DaCoTA

Collision reconstruction

Adrià Ferrer
Applus IDIADA



Directorate-General
for Mobility
and Transport

Project co-financed by the European Commission, Directorate-General for Mobility and Transport



Contents

- Accident description
- Accident simulation
- Adaptation to a feasible crash test
- Crash test
- Validation

The presentation introduces in the process of an accident reconstruction. The steps followed are the ones described in the slide.



Accident description

Accident description



The case studied in the training will be the base to explain the whole process. First of all, as explained in previous modules, all the information relative to the accident must be collected. Final positions, skid marks and deformations are critical.

Accident description

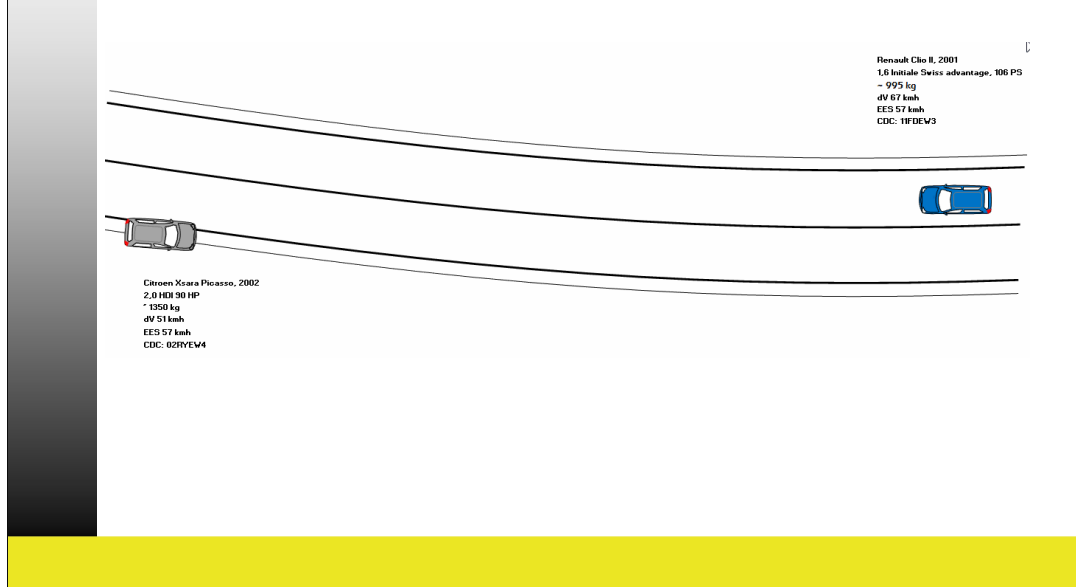

When visiting the scene, from the evidences found we can picture a possible situation. It is important to represent this sequence of events to match all the evidences.

Accident description



After investigating the scene, it is required to investigate the vehicles in a retrospective way. A first approach can be made at the scene but for safety reasons it is better to do it afterwards. This will provide valuable information such as deformation measures and interior evidences (like internal structural deformations).

Accident description



Injuries

- Citroen Xsara Picasso:

Position	MAIS
Driver	4
Passenger	Killed on scene
Rear left	2
Rear right	1

- Renault Clio:

Position	MAIS
Driver	1
Passenger	3

Also it is extremely important to have the medical information of the occupants. This will provide a very useful tool in the validation step.



Accident simulation

- Input variables:
 - Final positions
 - Collision point
 - Sketch
 - Wheel marks
 - Vehicle characteristics
 - Environmental damages
 - ...

The first step after the validation is the accident simulation. Nearly all the information collected in the accident investigation is valuable and can be introduced in the simulation software.

The accident simulation is generated with programs such as PC-Crash.

Accident simulation

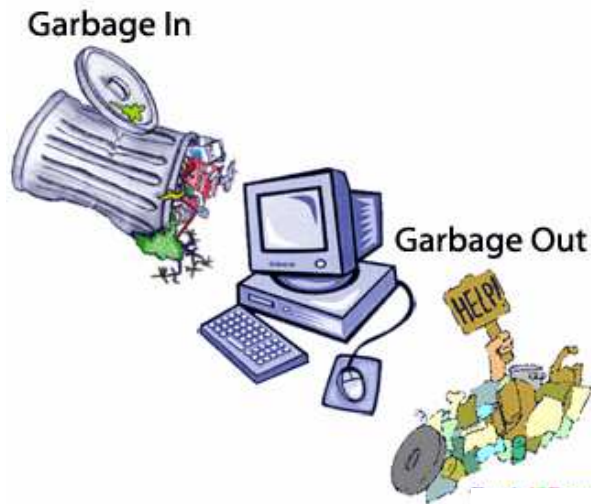

It is extremely important to get high quality information during the accident investigation because this information will have a direct influence in the simulation results. Anyway if we get a really high quality data, this doesn't mean that we will certainly get good results. The accident investigator must have his own criteria in order to determine when a simulation can be validated.



Accident simulation

- PC-Crash is a software for simulation and reconstruction of road accidents.
- It provides the user with kinetic and dynamic values and diagrams
- It also provides 3D visualization

As said before, the simulated is generated with PC-Crash. This software is based in complex physics base and it is one of the most reliable software in this field. However, we should take in account that what we will get is only a model, never the exact situation that happened. The reliability of the model is to be determined by the accident investigator

Accident simulation

- Vehicle modeling

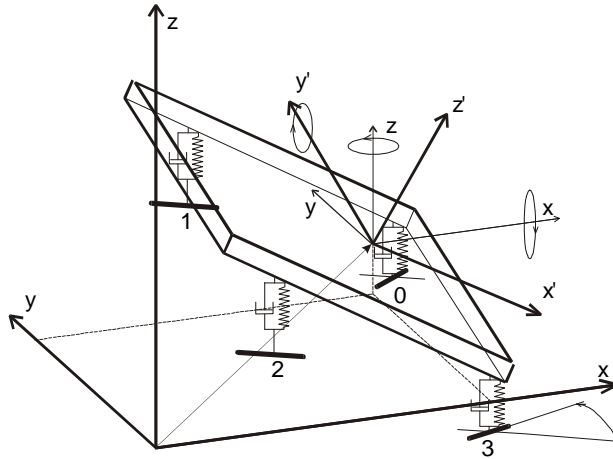

PC-Crash uses a large database with basic parameters for each car. Every car is modelled as shown in the slide.

- Trajectories simulation:
 - Kinematics: simple kinematics correlations between acceleration, velocity and position

 - Kinetic:
 - Wheel forces modeling
 - Movement equation
 - 6-axis equations
 - New CoG coordinates determination
 - Determination of the modified vertical forces

Also, PC-Crash simulates the vehicles' trajectories in two ways as explained in the slide.

- Collision models:
 - Kudlich-Slibar (restitution impulse):
 - Total impact
 - Scratch impact
 - Energetic method (EES)

Finally, PC-Crash can use different collision models depending on the case to be simulated. The investigator should define which one fits better to the nature of the crash but usually it is used the Kudlich-Slibar method. The choice also depends on the available information.

- Parameters introduced in this case:
 - Vehicles
 - Friction coefficient
 - Ditch profile
 - Number of occupants
 - Final positions
 - Velocity estimation

In the example case, the parameters from the slide were introduced.
The information introduced depends on the available information.



Accident simulation

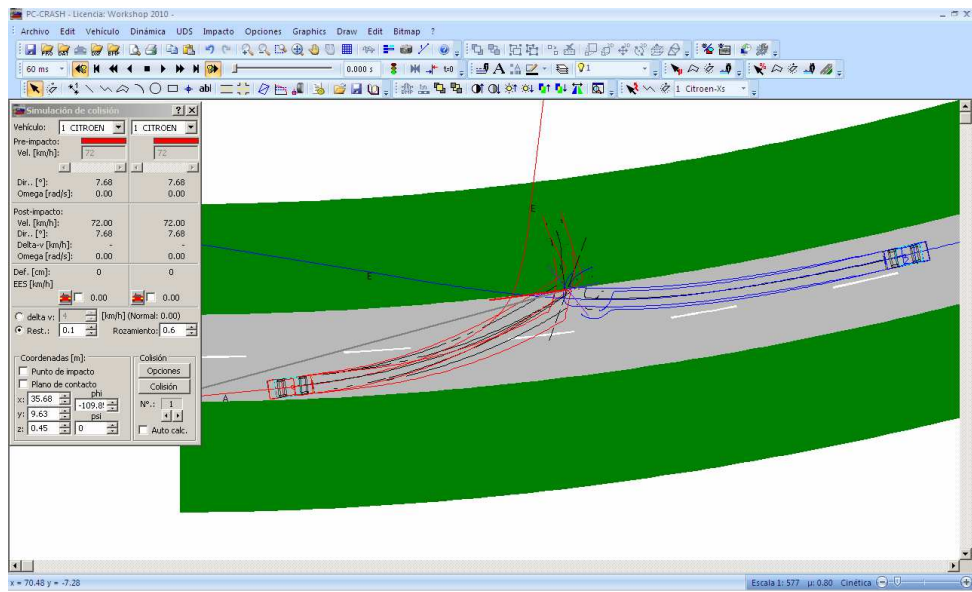

This is how PC-Crash looks like.



Accident simulation

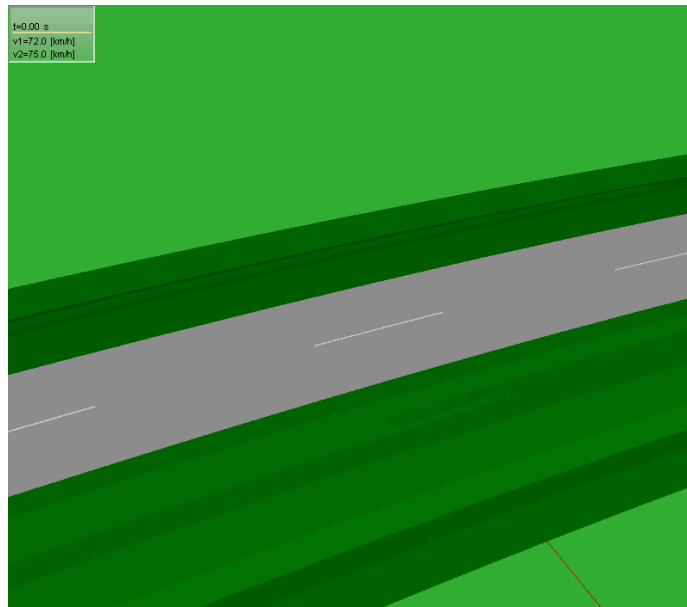

This is a video of the accident simulation

Accident simulation

- Validation:
 - It is false that once all the available data accident is introduced, the desired result is obtained
 - Acceptation of the simulation checking that some values are comparable to the ones in the real accident:
 - Pre-crash marks
 - Post-crash marks
 - Vehicle deformation (EES)
 - Final position

After the accident is simulated the validation step takes part in the process. The criteria is shown in the slide. If the case is not validated, a new simulation has to be made, entering in a iterative process until a simulation is approved.

Accident simulation

- Validation:

- EES:

	Real accident estimation	Simulation
Citroen	57 km/h	59 km/h
Renault	57 km/h	53 km/h

- Delta v:

	Real accident estimation	Simulation
Citroen	51 km/h	55 km/h
Renault	67 km/h	59 km/h

These are some of the validation parameters used in the example case.



Adaptation to a feasible crash test

Adaptation to a feasible crash test

- Crash testing

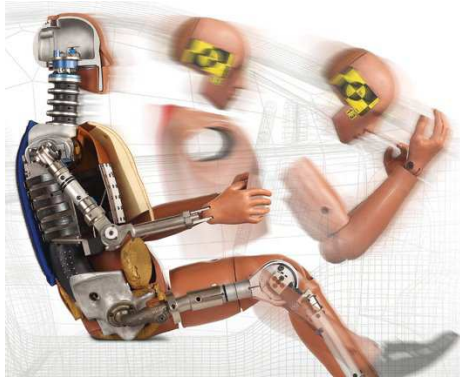

In order to reconstruct the case, we use second hand cars and dummies.

The dummies are human models that capture signals like acceleration or force in order to correlate this values with real injuries.



Adaptation to a feasible crash test

- Core variables determination:
 - Speed
 - Collision angle
 - Mass
 - Number of dummies

Also the real accident is usually impossible to represent as it really happened so an adaptation must be made. There are some core variables to determine and those shouldn't vary or vary the less possible.

Adaptation to a feasible reconstruction

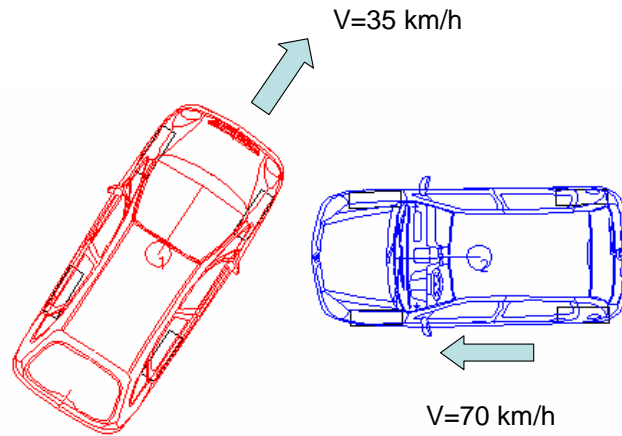

Finally this is the configuration adopted for the example case.



Crash test

Crash test

- As a first step a simulation of the new configuration is needed
- The variables used to validate the accident simulation should be compared with the ones obtained in this new simulation

In order to validate the configuration, a simulation of the reconstruction must be generated.

Crash test

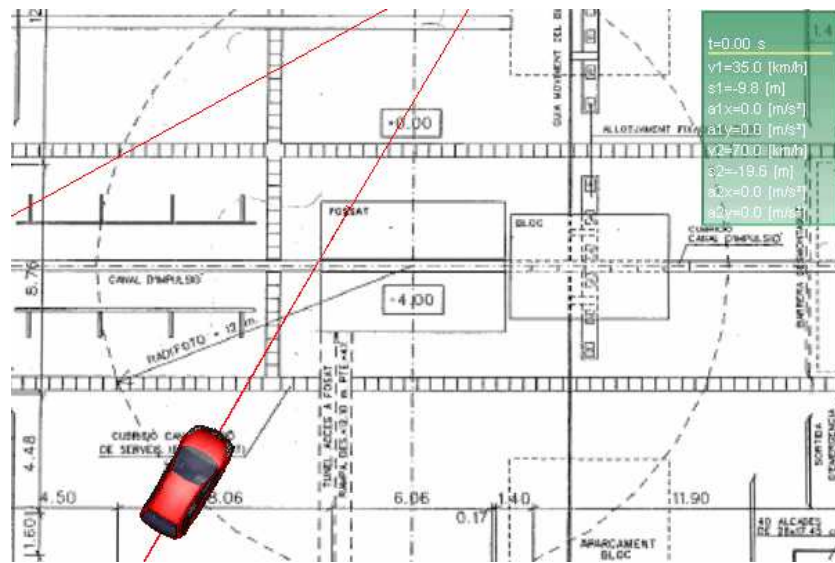

Video of the reconstruction simulation

Crash test

- Validation:

- EES:

	Real accident estimation	Accident simulation	Crash test simulation
Citroen	57 km/h	59 km/h	46 km/h
Renault	57 km/h	53 km/h	59 km/h

- Delta v:

	Real accident estimation	Accident simulation	Crash test simulation
Citroen	51 km/h	55 km/h	49 km/h
Renault	67 km/h	59 km/h	52 km/h

Validation parameters in the example case.

Crash test

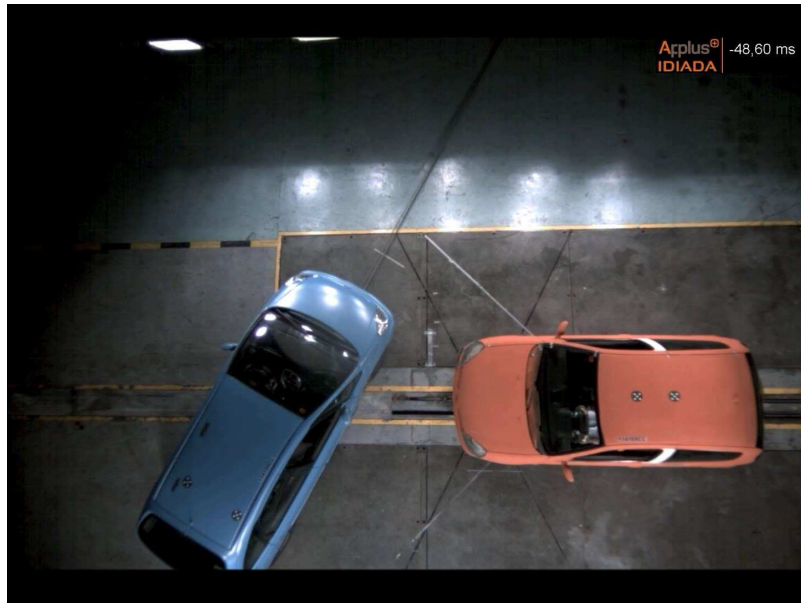

Crash video

Crash test

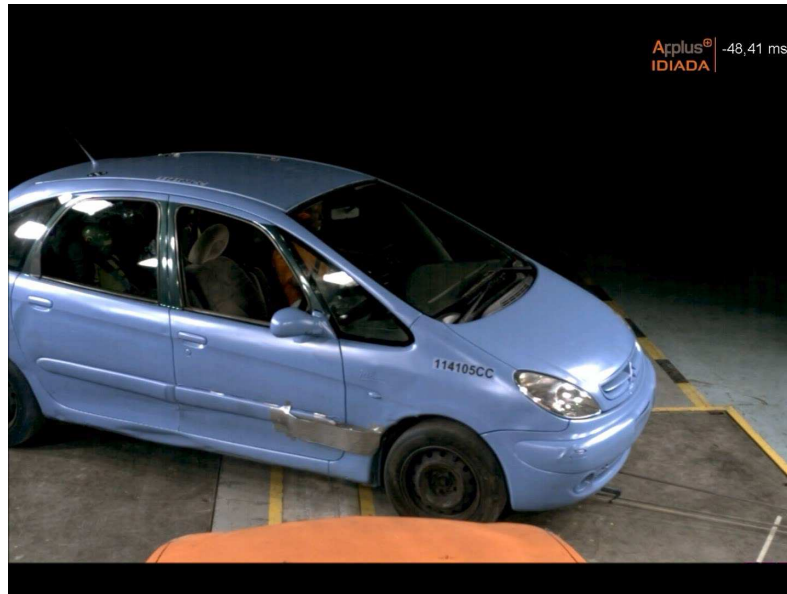

Crash video



Validation

- Parameters to validate the reconstruction:
 - Deformations (visual)
 - EES
 - CDC
 - Dummy signals

In order to validate the crash tests, some parameters are established.

- Deformations



Visual comparison is one of them

- Deformations





Validation

- CDC

Real accident	Crash test
11FDEW3	10FDEW3

The deformation coding is also a validation parameter



Validation

- Dummy signals:
 - Correlation with real accident injuries.

Finally, the data collected is compared to the real injuries in order to make a correlation.



Thank you for your attention